

*If you are looking
for **individual**
solutions. . .*



*. . . we
make them!*





1967



1968



1969



1969-70



1970



1971



1972



1979



1980



1981



1982



1983



1984



1985



1986



1987



1988



1991



1996



1996-97



1997



2003



2008



2009



2009

Made-to-measure materials handling equipment

Storage and distribution of mixed products is common in almost all sectors of industry.

Goods that are bulky and/or difficult to handle are a great challenge for businesses.

Transport, storage, handling and distribution: CORDES products are designed to perform each of these steps while minimising damage risks, handling times and personnel requirements.

THAT IS OUR GOAL

Index

A	Chapter Section . Page	M	
Accessories	A4.10	Magazine trolley	F1.33
Automatic base retainer	A4.10	Maxi-Safe-Corlette®	C3.30
Automobile industry	D3.10	Mini-Safe-Corlette®	C3.21
Auto-twist castor	Info 1.20, A4.10	Non-slip covering	B1.10
B		O	
Base panels	A4.10	Order-picking trolley	F1.33
Basic model	Info 1.10	P	
Bedroom box	B2.20	Pallet converters	E1.10
Beer tent furniture rack	D2.21	Pallet rack	A1.31, A5.30
Bicycle Corlette®	C2.10	Parcel trolley	C3.10, C3.11, C3.20, C3.31
Bicycle logistics	C2.11	Plastic pallet	E1.10
C		Potato Box	D2.22
Central brake	C2.11, C3.20	PVC protective clip	A1.10
Coating	A4.10	Q	
Combined stores	Info 1.10, A5.50	Quadro-Corlette®	C1.10
CORDES stacking rack	D2.11	R	
Corlettes®	A1.10 Order-picking trolley	Rack runners	A4.10
Corlettine	C1.11	Rack stores	Info 1.11, A1.30, A5.30
Coupling	A4.10	Rolling container	F1.30
D		Rolling Container	F1.21
Distribution logistics	F1.31	Rolling garment rack	F1.11
Dolly	B1.10	S	
Dolly collector	B1.11	Safe Corlette®	C3.10, C3.11, C3.20
Double door	A4.10, C3.30	Securing strap	A4.10
Double-rail rolling garment rack	F1.11	Shelf hooks	A4.10
Double-wall panels	A4.10	Shelves	A4.10, B2.10, C3.21, D1.20, E1.21, E2.21
Drawbar	A4.10	Side hook	A4.10
E		Silencer box	F1.20
Europa dolly	B1.11	Stack claws	A4.10
Euro-pallets	E1.10	Stacker pockets	A4.10
F		Stacking plates	D1.10
Foam plastic protection	A4.10	Stacking racks	D1.10
Front door	A4.10	Stanchion stacking rack	D1.21
Fully automated high-rise stores	Info 1.10, A5.40	Standard-Corlette®	A2.10
FurniBox®	A1.10	Store types	Info 1.10
Garment container	F1.10	Supporting arm	A1.10, A4.10, B2.20, F1.20
H		T	
Heavy-duty Container	D2.10	Textile container	F1.10
Heavy-duty stacking rack	D1.10	Thread guard	A4.10
High-density stores	Info 1.11, A5.20	Truck traffic	A3.10, C1.10, C2.10, C3.10
High-rise stores	Info 1.10, A5.30, A5.40	Tyre stacking rack	D1.20
I		U	
Individual solutions	F1.10	Universal-Corlette®	A3.10
Industrial pallets	E1.10	Upholstered element trolley	B2.11
L		Upholstered suite trolley	B2.10
Labelling elements	A4.10	V	
Laundry trolley	F1.21	Vario stacking rack	D2.20
Leather transport trolley	F1.11	W	
Letter container trolley	C3.31	Weatherproof	A3.30, D2.21, E1.31, F1.21, F1.30
Load securing tube	A1,20, A4.10, F1.20	Wheel direction lock	A4.10
Low-rise stores	Info 1.11, A5.10		



Contents

	<i>Chapter</i>	<i>Section</i>	<i>Page</i>
- Basic models / store overview			<i>Info</i> 1.10
- Auto-twist castor			<i>Info</i> 1.20
Corlettes®			
- FurniBox®	A	1.10	
- FurniBox® for fully automated high-rise store	A	1.20	
- Corlette® in rack	A	1.30	
- Standard-Corlette®	A	2.10	
- Universal-Corlette®/ painted version	A	3.10	
- Universal-Corlette®/ wire mesh	A	3.20	
- Universal-Corlette®/ galvanised version	A	3.30	
- Accessories	A	4.10	
- Store types			
- Low-rise stores	A	5.10	
- High-density stores	A	5.20	
- Rack stores	A	5.30	
- Fully automated high-rise stores	A	5.40	
- Combined stores	A	5.50	
- Examples of use	A	6.10	
Trolley			
- Dolly®	B	1.10	
- Dolly collector	B	1.11	
- Upholstered suite/element trolley	B	2.10	
- Bedroom box	B	2.20	
- Examples of use	B	2.21	
Transport container			
- Quadro-Corlette®	C	1.10	
- Corlettine	C	1.11	
- Bicycle Corlette®	C	2.10	
- Bicycle logistics	C	2.11	
- Safe-Corlette®	C	3.10	
- Mini-Safe-Corlette®	C	3.21	
- Maxi-Safe-Corlette®	C	3.30	
- Letter and parcel trolleys	C	3.31	
- Examples of use	C	3.40	
Stacking racks			
- Heavy-duty stacking rack	D	1.10	
- Tyre stacking rack	D	1.20	
- Stanchion stacking rack	D	1.21	
- Heavy-duty Cortainer	D	2.10	
- CORDES stacking rack	D	2.11	
- Vario stacking rack	D	2.20	
- Beer tent furniture rack	D	2.21	
- Potato Box	D	2.22	
- Automotive container	D	3.10	
- Examples of use	D	4.10	
Pallet converter			
- Painted versions	E	1.10	
- Galvanised versions	E	1.31	
- Examples of use	E	3.10	
Individual solutions			
- Textile container	F	1.10	
- Rolling garment rack / leather transport trolley	F	1.11	
- Silencer box	F	1.20	
- Rolling Cortainer / laundry trolley	F	1.21	
- Rolling container	F	1.30	
- Cordes and logistics service providers	F	1.31	
- Order-picking trolleys / magazine trolleys	F	1.33	
CORDES worldwide			
- Sales partners			<i>Info</i> 1.30





Behind every strong brand is a strong manufacturer.

CORDES gives your customers the benefit of an experienced manufacturer's flexibility. Tried-and-tested logistics permit instant delivery, even of large quantities. Developing customer-specific solutions and producing variants to special order is our day-to-day business. We can do this because we have the necessary design and production capacity and highly trained skilled personnel. We are the competent contacts for resellers and their customers. Cordes has nearly half a century of manufacturing competence behind it. In other words, **CORDES** stands for sophisticated quality products and for speedy, reliable delivery based on an efficient logistics chain.



The "fold trick"

Every Corlette® folds away in a trice and takes up a minimum of space when empty. This saves storage space and cuts freight costs.

An Invention of CORDES



Corlette® Basics

Corlettes® are the made-to-measure solution. Suitable for low-rise, high-rise and high-density storage. Robust tubular steel frame construction. High-grade synthetic resin coating, blue RAL 5012, wheels: 100 mm plastic, 3 swivel castors and 1 directional wheel. Upgradable with special accessories. See Chapter A. 4.10



FurniBox®
1300, 2000, 2500, 2700

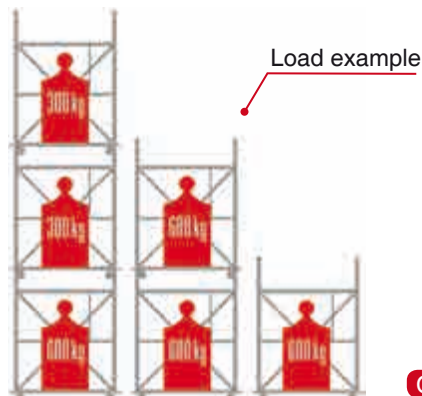

Chapter A 1.10

Standard-Corlette®
1300, 2000, 2500

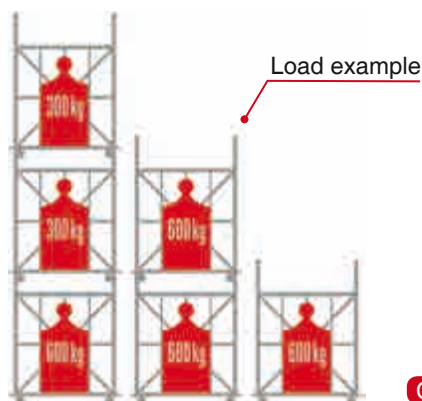

Chapter A 2.10

Universal-Corlette®
1200, 2000, 2400



wire sides and galvanized

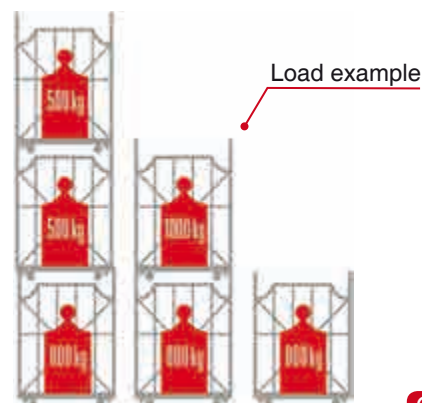

Chapter A 3.10

Corlette®

Corlette® and . . .

. . . low-rise stores



Tidy and secure furniture storage without racks. But with speedy trouble-free access!

Chapter A 5.10

. . . high-density stores



Make optimum use of the spare space above your products.

Chapter A 5.20

. . . Corlette and pallet rack stores



Speedy direct access to your products, regardless of their level in your pallet/ Corlette rack store.

Chapter A 5.30

. . . fully-automated high-rise stores



The Corlette® is perfect even for the latest computer-controlled high-rise stores: you can make hundreds of insertions and removals per day without a large workforce.

Chapter A 5.40

. . . combined stores

Chapter A 5.50

Auto-twist castor

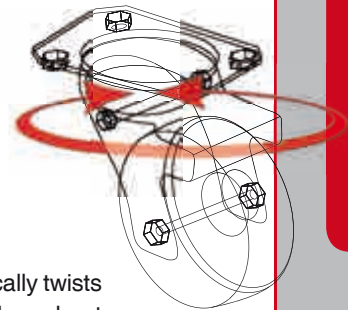

CORDES has modified the Corlette® to fit pallet racks. The auto-twist castor makes it possible. It automatically twists to a position that allows the Corlette to slot into a pallet rack just like a Euro-pallet. So there is no problem about using **CORDES** Corlettes® in a rack system in combination with Euro-pallets.

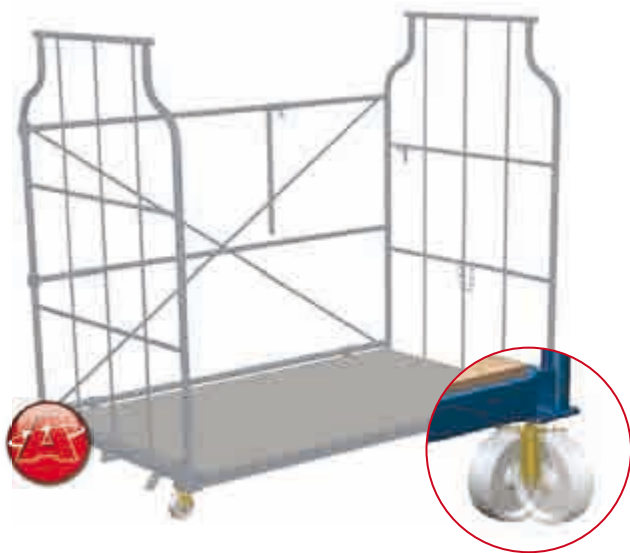

The **auto-twist castor** which means any Corlette® can be stacked in a pallet rack. The end position of the auto-twist castor can be set to cater for various rack dimensions. The Corlettes® indicated can be supplied with the auto-twist castor.



Corlette® and Euro-pallet in one rack

The auto-twist castor

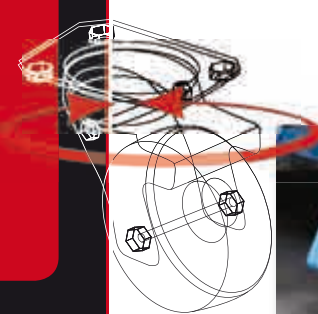

The Corlette® with the auto-twist castor is as easy as ever to move.



As soon as the Corlette® is lifted and is no longer resting on the ground, the auto-twist castors spring from wherever they are to a predefined position.



The position of the castors between the cross-members means the Corlette® is secured against sliding.



So the **CORDES** auto-twist castor guides your products in the Corlette® safely into the pallet rack.



Corlette®

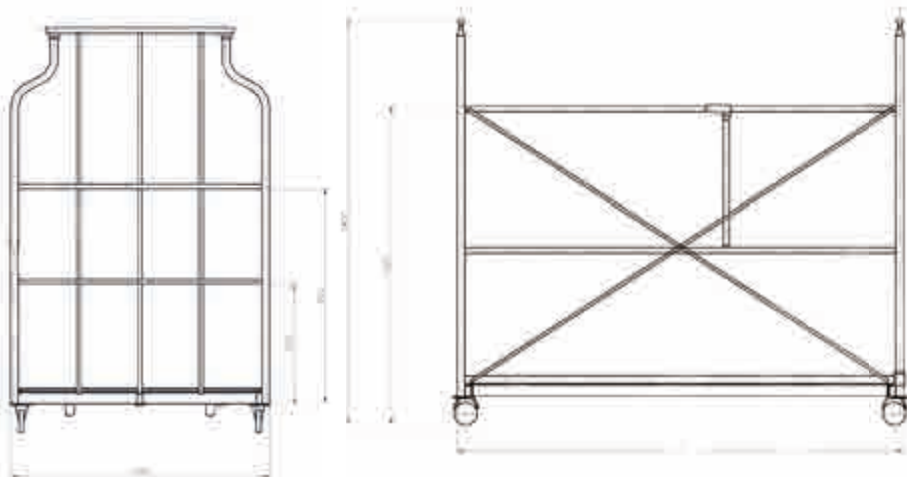

Corlette®

Corlette®

Corlette®

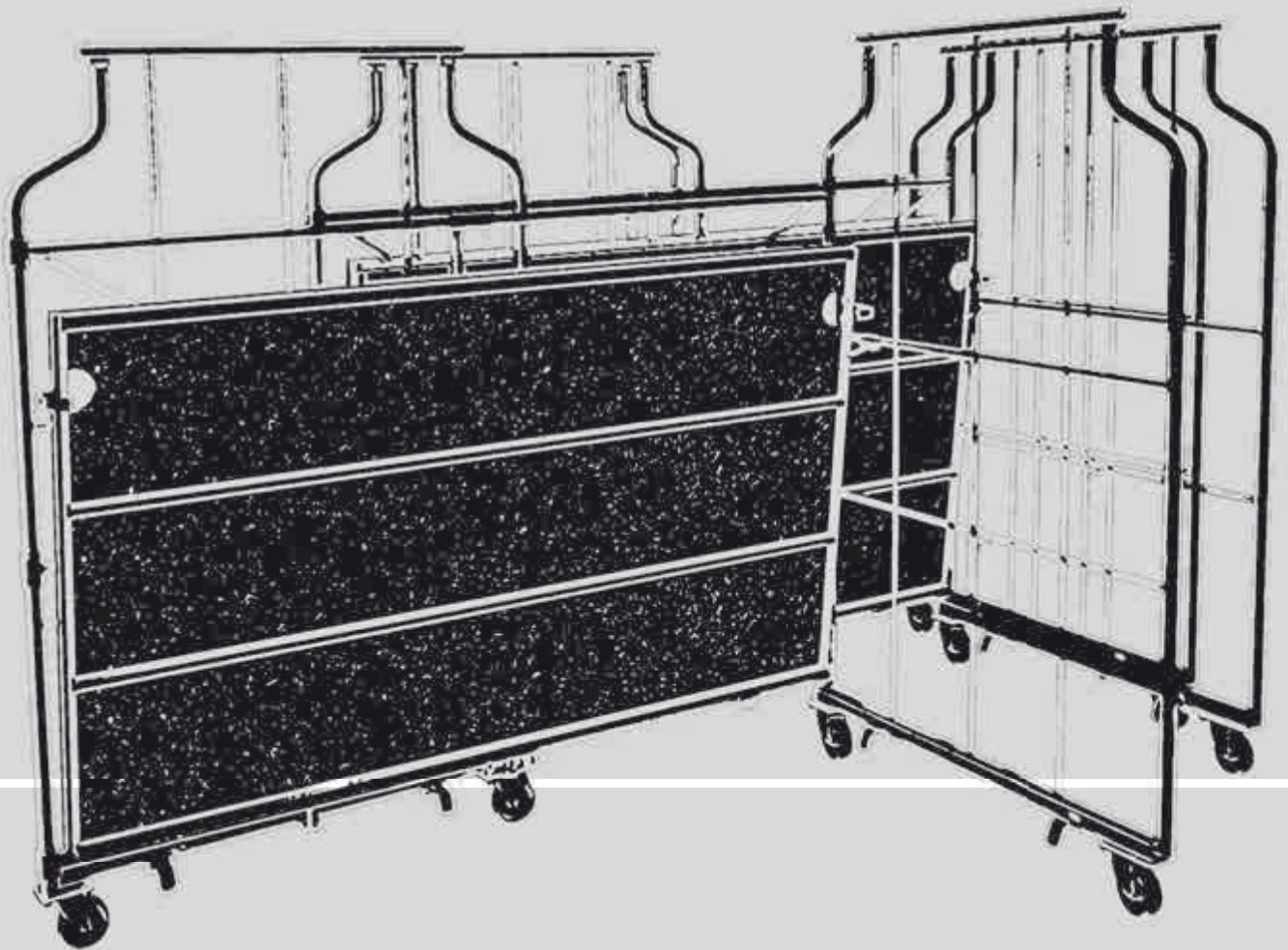

FurniBox®



The FurniBox® is right for almost all goods in internal transport and storage. Stacked three high, it makes full use of the storage height. Both manually and towed, our FurniBox® will go everywhere you need it.

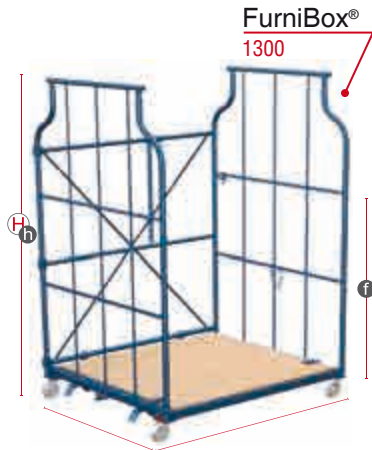

Article No. mc-130.501

Dimensions	Weight	Load cap.	Support cap.	Stackable	Wheel diam.
W / D / H mm	kg	kg	kg		mm
1300 / 1150 / 1800					
Internal dimensions	69	600	600	3 high	100
w / d / h mm					
1210 / 1100 / 1610					

Loading height: 190 mm, underclearance: 135 mm. Tubular and flat steel struts:
 f. horizontal tube in side wall: 910 mm from top of base plate to top of tube
 Colour: Light blue RAL 5012
 Wheels: 4 x 100 mm plastic swivel castors, with wheel direction lock



Article No. mc-200.501

Dimensions	Weight	Load cap.	Support cap.	Stackable	Wheel diam.
W / D / H mm	kg	kg	kg		mm
2000 / 1150 / 1800					
Internal dimensions	85	600	600	3 high	100
w / d / h mm					
1910 / 1100 / 1610					

Loading height: 190 mm, underclearance: 135 mm. Tubular and flat steel struts:
 f. horizontal tube in side wall: 910 mm from top of base plate to top of pipe
 Colour: Light blue RAL 5012
 Wheels: 4 x 100 mm plastic swivel castors, with wheel direction lock



Available in all dimensions



Can be equipped with automatic role



Stackable



Low-rise stores



High-density stores



Expandable with accessories



Special design possible



individual adaptation



nested



3 years warranty

Corlette®





Furnibox®
folded state



Empty Corlettes® of the types indicated can be nested to save space by using the “**fold trick**”.

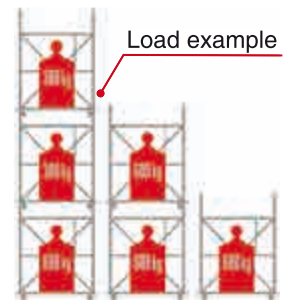

accessories in
Chapter A 4.10



Available in all dimensions



Can be equipped with automatic role



Stackable



Low-rise stores



High-density stores



Expandable with accessories



Special design possible



individual adaptation



nested



3 years warranty

Furnibox®
2500



Article. No. **mc-250.501**

Dimensions	Weight	Load cap.	Support cap.	Stackable	Wheel diam.
W / D / H mm	kg	kg	kg		mm
2500 / 1150 / 1800					
Internal dimensions	105	600	600	3 high	100
w / d / h mm					
2380 / 1100 / 1610					

Load surface height: 200 mm, underclearance: 134 mm. Tubular and flat steel struts:
f. horizontal tube in side wall: 710 mm from top of base panel to top of tube
g. horizontal tube in side wall: 910 mm from top of base panel to top of tube
 Colour: Light blue RAL 5012
 Wheels: 4 x 100 mm plastic swivel castors, one with wheel direction lock

Furnibox®
2700



Article. No. **mc-270.501**

Dimensions	Weight	Load cap.	Support cap.	Stackable	Wheel diam.
W / D / H mm	kg	kg	kg		mm
2700 / 1150 / 1800					
Internal dimensions	111	600	600	3 high	100
w / d / h mm					
2610 / 1100 / 1600					

Load surface height: 200 mm, underclearance: 134 mm. Tubular and flat steel struts:
f. horizontal tube in side wall: 710 mm from top of base panel to top of tube
g. horizontal tube in side wall: 910 mm from top of base panel to top of tube
 Colour: Light blue RAL 5012
 Wheels: 4 x 100 mm plastic swivel castors, one with wheel direction lock



FurniBox[®] fully automatic high-rise pallet store

More than 15000 Corlettes[®] in a high-rise pallet store are moved around as if by magic and transported to the dizzy height of 47 metres. Such a high-rise pallet store can handle hundreds of inward and outward movements every day with a minimum of personnel requirements.

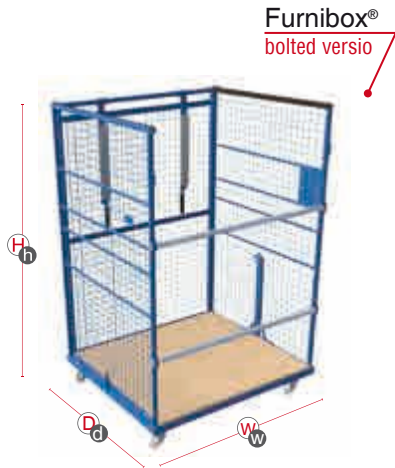

Dimensions	Weight	Load cap.	Support cap.	Stackable	Wheel diam.
W / D / H mm	kg	kg	kg		mm
1323 / 1150 / 1955	132	1000	-	-	125
Internal dimensions					
w / d / h mm					
1239 / 1099 / 1724					

Load surface height: 230 mm, underclearance: 163 mm,
Mesh size 50 x 50 mm
Wheels: 4 x 125 mm plastic swivel castors, one with wheel direction lock



Dimensions	Weight	Load cap.	Support cap.	Stackable	Wheel diam.
W / D / H mm	kg	kg	kg		mm
2748 / 1150 / 1955	163	1000	-	-	125
Internal dimensions					
w / d / h mm					
2664 / 1099 / 1724					

Load surface height: 230 mm, underclearance: 163 mm,
Mesh size 50 x 50 mm
Wheels: 4 x 125 mm plastic swivel castors, one with wheel direction lock

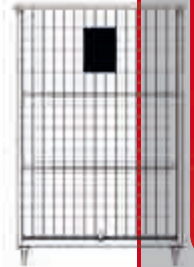

Corlette[®]





Furnibox®
folded state

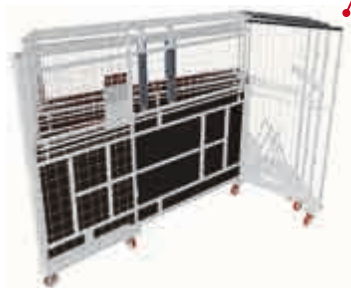

Empty Corlettes® of the types indicated can be nested to save space by using the “fold trick”.



accessories in
Chapter A 4.10



Available in all dimensions



Can be equipped with automatic roller



Fully automated high-rise stores



Low-rise stores



Expandable with accessories



Special design possible



individual adaptation



nested



3 years warranty

Furnibox®
foldable



Furnibox®
foldable



Dimensions	Weight	Load cap.	Support cap.	Stackable	Wheel diam.
W / D / H mm	kg	kg	kg		mm
1300 / 1150 / 2030					
Internal dimensions					
w / d / h mm	127	750	-	-	125
1215 / 1085 / 1800					

Load surface height: 220 mm, underclearance: 163 mm,
Mesh size 100 x 100 mm
Colour: Light grey RAL 7035
Wheels: 4 x 125 mm polyurethane swivel castors (96° Shore),
one with wheel direction lock

Dimensions	Weight	Load cap.	Support cap.	Stackable	Wheel diam.
W / D / H mm	kg	kg	kg		mm
2700 / 1150 / 2030					
Internal dimensions					
w / d / h mm	195	850	-	-	125
2615 / 1085 / 1800					

Load surface height: 220 mm, underclearance: 163 mm,
Mesh size 100 x 100 mm
Colour: Light grey RAL 7035
Wheels: 4 x 125 mm polyurethane swivel castors (96° Shore),
one with wheel direction lock



Corlette® in rack

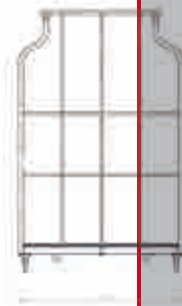

Optimum use of rack bays with a clear width of 4.30 m is possible with

- 2 x FurniBox® 2000 or
- 3 x FurniBox® 1300 or
- 1 x FurniBox® 2700 and
- 1 x FurniBox® 1300

The two cross-members of the rack compartment should be 770 mm deep (external over all) specifically for the rack runners of FurniBoxes®; the insertion height of the support bars should ideally be 2500 mm for upholstered furniture and 3200 mm for all other furniture.

This rack system is already in widespread use. If you would like to see it "in the flesh", we'll be glad to arrange an appointment.



The rack runners also ensure the necessary underclearance for the stacker forks.



Corlette® in rack

Pallet rack
with loaded EURO-Pallette



In practice there are also Corlette high-rise systems that store not only Corlettes but also Euro-pallets. As a rule, the pallets are used at ground level and are limited to an intermediate height of 1.5 m. On the other hand there are also pallet-rack systems with the typical dimensions that store Corlettes. However, as with storage of pallets in the Corlette rack, either the rack must be equipped with distance supports or the Corlettes must be adapted to the dimensions of the pallet rack, e.g. with the auto-twist castor.



Auto-twist castor in Chapter **Info 1.20**

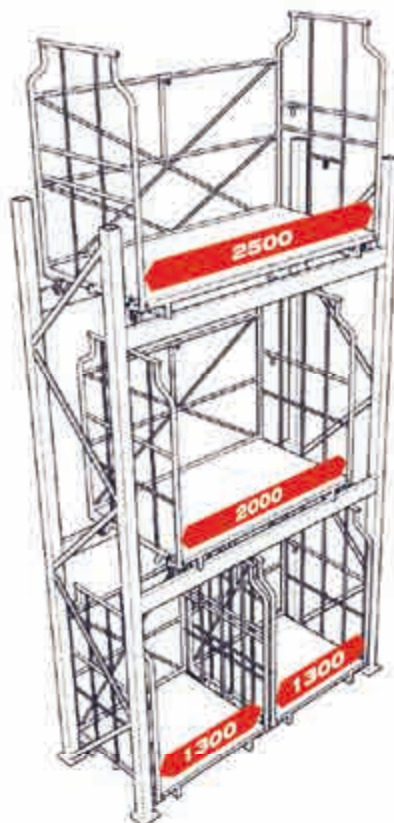

A high-rise store with Corlettes combines the advantages of the Corlette with the height utilisation of the rack system. When the Corlette is inserted in a high-rise rack, the excess over the external height of the Corlette is only limited by the height of the rack compartment, which can be freely selected between 2 m and 5 m. In conjunction with computerised storage management, other advantages include reduced complaint rates and virtually 100-percent stock security. All movements in the store can be fully optimised by IT. High-rise storage is particularly effective if an inserted Corlette carries only one article or the articles belonging to one order, so that there is no need for multiple access to a Corlette involving several insertion and removal operations.



Auto-twist castor in Chapter **Info 1.20**

Standard-Corlette®

The Standard Corlette® is right for almost all goods in internal materials handling and storage. By stacking three-high it is possible to make full use of the storage height. Both manually and towed, our Corlettes® are easily moved to wherever they are needed.

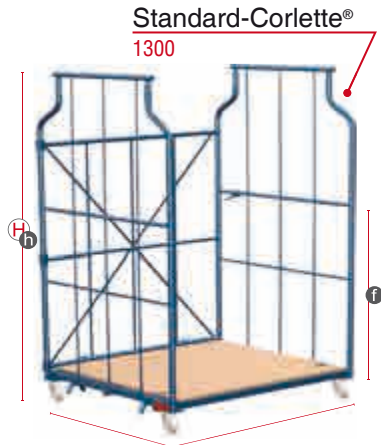

Article. No. sc-130.500

Dimensions	Weight	Load cap.	Support cap.	Stackable	Wheel diam.
W / D / H mm	kg	kg	kg		mm
1300 / 1150 / 1800	70	600	600	3 high	100
Internal dimensions					
w / d / h mm					
1210 / 1100 / 1610					

Load surface height: 190 mm, underclearance: 135 mm. Tubular and flat steel struts:
 f. horizontal round tube in side wall: 910 mm from top of base panel to top of transverse tube
 Colour: Light blue RAL 5012
 Wheels: 4 x 100 mm plastic swivel castors, one with wheel direction lock



Article. No. sc-200.500

Dimensions	Weight	Load cap.	Support cap.	Stackable	Wheel diam.
W / D / H mm	kg	kg	kg		mm
2000 / 1150 / 1800	88	600	600	3 high	100
Internal dimensions					
w / d / h mm					
1910 / 1100 / 1610					

Load surface height: 190 mm, underclearance: 135 mm. Tubular and flat steel struts:
 f. horizontal tube in side wall: 910 mm from top of base panel to top of transverse tube
 Colour: Light blue RAL 5012
 Wheels: 4 x 100 mm plastic swivel castors, one with wheel direction lock



Available in all dimensions



Can be equipped with automatic role



Stackable



Low-rise stores



High-density stores



Expandable with accessories



Special design possible



individual adaptation



nested



3 years warranty

Corlette®





Available in all dimensions



Can be equipped with automatic role



Stackable



Low-rise stores



High-density stores



Expandable with accessories



Special design possible



individual adaptation



nested



3 years warranty

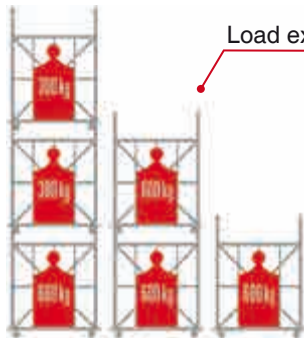

Load example



Standard-Corlette®
folded state



Standard-Corlette®
2500

Empty Corlettes® of the types indicated can be nested to save space by using the “fold trick”.

accessories in
Chapter A 4. 10

Article. No. **sc-250.500**

Dimensions W / D / H mm	Weight kg	Load cap. kg	Support cap. kg	Stackable	Wheel diam. mm
2500 / 1150 / 1800	105	600	600	3 high	100
Internal dimensions w / d / h mm					
2380 / 1100 / 1610					

Load surface height: 190 mm, underclearance: 135 mm. Tubular and flat steel struts:
f. horizontal tube in side wall: 910 mm from top of base panel to top of transverse tube
Colour: Light blue RAL 5012
Wheels: 4 x 100 mm plastic swivel castors, one with wheel direction lock



Universal-Corlette®

The transport appliance for internal materials handling and for truck traffic: robust collision protection in channel-iron base frame. Two Universal Corlettes® fit side by side on a truck and secure each other. Automatic base closure and quick opening by single-handed release.

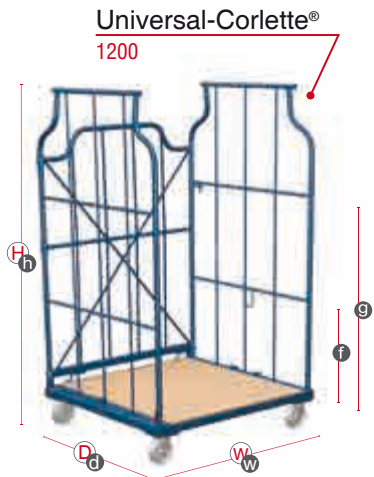

Article No. uc-120.500

Dimensions W / D / H mm	Weight kg	Load cap. kg	Support cap. kg	Stackable	Wheel diam. mm
1200 / 1150 / 1850	89	800	1000	3 high	125
Internal dimensions w / d / h mm					
1120 / 1100 / 1615					

Load surface height: 235 mm, underclearance: 165 mm. Round tube and flat steel strut
f. horizontal tube in side wall: 500 mm,
g. horizontal tube in side wall: 1005 mm from top of base panel to top of transverse tube.
 Colour: Light blue RAL 5012
 Wheels: 4 x 125 mm plastic swivel castors, one with wheel direction lock



Article No. uc-200.500

Dimensions W / D / H mm	Weight kg	Load cap. kg	Support cap. kg	Stackable	Wheel diam. mm
2000 / 1150 / 1850	115	800	1000	3 high	125
Internal dimensions w / d / h mm					
1920 / 1100 / 1615					

Load surface height: 235 mm, underclearance: 165 mm. Round tube and flat steel strut
f. horizontal tube in side wall: 500 mm,
g. horizontal tube in side wall: 1005 mm from top of base panel to top of transverse tube.
 Colour: Light blue RAL 5012
 Wheels: 4 x 125 mm plastic swivel castors, one with wheel direction lock



Available in all dimensions



Can be equipped with automatic role



Stackable



Low-rise stores



High-density stores



Expandable with accessories



Special design possible



Truck fit



Individual adaptation



nested



3 years warranty

Corlette®



Available in all dimensions



Can be equipped with automatic roller



Stackable



Low-rise stores



High-density stores



Expandable with accessories



Special design possible



Truck fit



individual adaptation



nested



3 years warranty

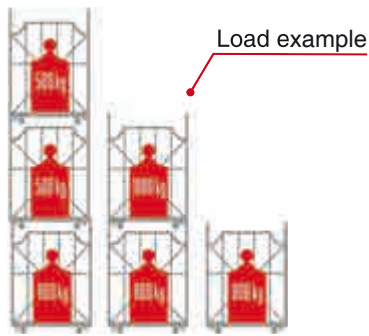

Universal-Corlette®
folded state



Universal-Corlette®
2400



Empty Corlettes® of the types indicated can be nested to save space by using the “fold trick”.



accessories in
Chapter A 4.10

Article No. uc-240.500

Dimensions	Weight	Load cap.	Support cap.	Stackable	Wheel diam.
W / D / H mm	kg	kg	kg		mm
2400 / 1150 / 1850					
Internal dimensions	132	800	1000	3 high	125
w / d / h mm					
2320 / 1100 / 1615					

Load surface height: 235 mm, underclearance: 165 mm. Round tube and flat steel strut
 f. horizontal tube in side wall: 500 mm,
 g. horizontal tube in side wall: 1005 mm from top of base panel to top of transverse tube.
 Colour: Light blue RAL 5012
 Wheels: 4 x 125 mm plastic swivel castors, one with wheel direction lock



Universal-Corlette®

wire sides

The solution for both internal materials handling and truck traffic. Robust collision protection in channel-iron base frame. Universal Corlettes fit side by side on a truck and secure each other. The base can be opened quickly by a single-handed release and closes automatically and securely when lowered.



Universal-Corlette®
1200 x 800

Article. No. **uc-120.598**

Dimensions W / D / H mm	Weight kg	Load cap. kg	Support cap. kg	Stackable	Wheel diam. mm
1200 / 800 / 1850	80	800	1000	3 high	125
Internal dimensions w / d / h mm					
1120 / 750 / 1615					

Load surface height: 235 mm, underclearance: 165 mm. Round tube and wire sides
f. horizontal tube in side wall: 500 mm,
g. horizontal tube in side wall: 1005 mm from top of base panel to top of transverse tube.
 Colour: Light blue RAL 5012, mesh size: 50 x 100 mm
 Wheels: 4 x 125 mm plastic swivel castors, one with wheel direction lock



Universal-Corlette®
1200 x 1150

Article. No. **uc-120.599**

Dimensions W / D / H mm	Weight kg	Load cap. kg	Support cap. kg	Stackable	Wheel diam. mm
1200 / 1150 / 1850	95	800	1000	3 high	125
Internal dimensions w / d / h mm					
1120 / 1100 / 1615					

Load surface height: 235 mm, underclearance: 165 mm. Round tube and wire sides
f. horizontal tube in side wall: 500 mm,
g. horizontal tube in side wall: 1005 mm from top of base panel to top of transverse tube.
 Colour: Light blue RAL 5012, mesh size: 50 x 100 mm
 Wheels: 4 x 125 mm plastic swivel castors, one with wheel direction lock

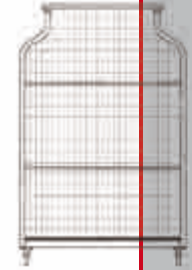

- Available in all dimensions
- Can be equipped with automatic role
- Stackable
- Low-rise stores
- High-density stores
- Expandable with accessories
- Special design possible
- Truck fit
- Individual adaptation
- nested
- 3 years warranty

Corlette®

Universal-Corlette® folded state



Empty Corlettes® of the types indicated can be nested to save space by using the “fold trick”

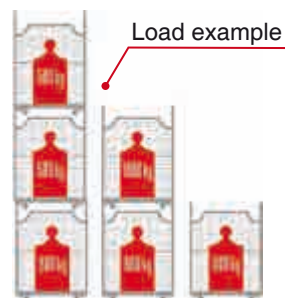

Load example

accessories in
Chapter A 4.10

Universal-Corlette® 2000



Article. No. **uc-200.599**

Dimensions W / D / H mm	Weight kg	Load cap. kg	Support cap. kg	Stackable	Wheel diam. mm
2000 / 1150 / 1850	122	600	600	3 high	125
Internal dimensions w / d / h mm					
1920 / 1100 / 1615					

Load surface height: 235 mm, underclearance: 165 mm. Round tube and flat steel strut
f. horizontal tube in side wall: 500 mm,
g. horizontal tube in side wall: 1005 mm from top of base panel to top of transverse tube.
 Colour: Light blue RAL 5012, mesh size: 50 x 100 mm
 Wheels: 4 x 125 mm plastic swivel castors, one with wheel direction lock

Universal-Corlette® 2400



Article. No. **uc-240.599**

Dimensions W / D / H mm	Weight kg	Load cap. kg	Support cap. kg	Stackable	Wheel diam. mm
2400 / 1150 / 1850	140	800	1000	3 high	125
Internal dimensions w / d / h mm					
2320 / 1100 / 1615					

Load surface height: 235 mm, underclearance: 165 mm. Round tube and flat steel strut
f. horizontal tube in side wall: 500 mm,
g. horizontal tube in side wall: 1005 mm from top of base panel to top of transverse tube.
 Colour: Light blue RAL 5012, mesh size: 50 x 100 mm
 Wheels: 4 x 125 mm plastic swivel castors, one with wheel direction lock



Available in all dimensions



Can be equipped with automatic roller



Stackable



Low-rise stores



High-density stores



Expandable with accessories



Special design possible



Truck fit



Individual adaptation



nested



3 years warranty



Universal-Corlette®

wire sides and galvanized

Weatherproof galvanized Universal-Corlettes® with base panels of film-coated plywood with screen-printed surface are perfect for external materials handling and outdoor use.



Universal-Corlette®
1200 x 800

Article. No. **vc-120.598**

Dimensions W / D / H mm	Weight kg	Load cap. kg	Support cap. kg	Stackable	Wheel diam. mm
1200 / 800 / 1850	82	800	1000	3 high	125
Internal dimensions w / d / h mm					
1120 / 750 / 1615					

Load surface height: 235 mm, underclearance: 165 mm. Round tube and flat steel strut
f. horizontal tube in side wall: 500 mm,
g. horizontal tube in side wall: 1005 mm from top of base panel to top of transverse tube.
 Colour: galvanized
 Wheels: 4 x 125 mm plastic swivel castors, one with wheel direction lock



Universal-Corlette®
1200 x 1150

Article. No. **vc-120.599**

Dimensions W / D / H mm	Weight kg	Load cap. kg	Support cap. kg	Stackable	Wheel diam. mm
1200 / 1150 / 1850	95	800	1000	3 high	125
Internal dimensions w / d / h mm					
1120 / 1100 / 1615					

Load surface height: 235 mm, underclearance: 165 mm. Round tube and flat steel strut
f. horizontal tube in side wall: 500 mm,
g. horizontal tube in side wall: 1005 mm from top of base panel to top of transverse tube.
 Colour: galvanized
 Wheels: 4 x 125 mm plastic swivel castors, one with wheel direction lock

the Corlettes® protect each other



Available in all dimensions



Can be equipped with automatic role



Stackable



Low-rise stores



High-density stores



Expandable with accessories



Weatherproof



Special design possible



Truck fit



individual adaptation



nested



3 years warranty

Corlette®

Universal-Corlette®
folded state



Empty Corlettes® of the types indicated can be nested to save space by using the “fold trick”

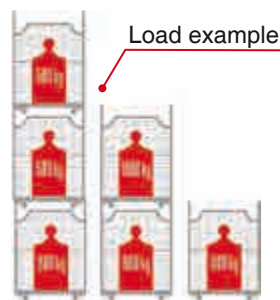

Load example

accessories in
Chapter A 4.10

Universal-Corlette®
2000



Article. No. **vc-200.599**

Dimensions W / D / H mm	Weight kg	Load cap. kg	Support cap. kg	Stackable	Wheel diam. mm
2000 / 1150 / 1850					
Internal dimensions w / d / h mm	122	600	600	3 high	125
	1920 / 1100 / 1615				

Load surface height: 235 mm, underclearance: 165 mm. Round tube and flat steel strut
f. horizontal tube in side wall: 500 mm,

g. horizontal tube in side wall: 1005 mm from top of base panel to top of tube.

Colour: galvanised

Wheels: 4 x 125 mm plastic swivel castors, one with wheel direction lock

Universal-Corlette®
2400

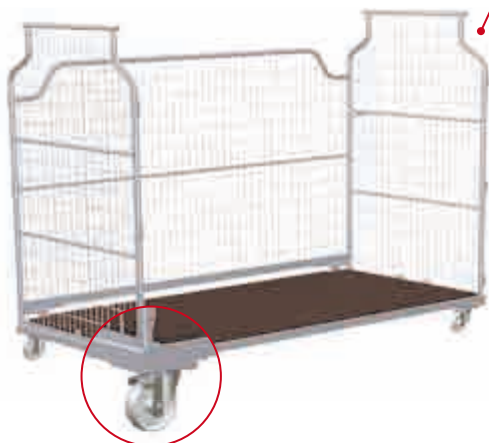

Article. No. **vc-240.599**

Dimensions W / D / H mm	Weight kg	Load cap. kg	Support cap. kg	Stackable	Wheel diam. mm
2400 / 1150 / 1850					
Internal dimensions w / d / h mm	140	800	1000	3 high	125
	2320 / 1100 / 1615				

Load surface height: 235 mm, underclearance: 165 mm. Round tube and flat steel strut
f. horizontal tube in side wall: 500 mm,

g. horizontal tube in side wall: 1005 mm from top of base panel to top of tube.

Colour: galvanised

Wheels: 4 x 125 mm plastic swivel castors, one with wheel direction lock



Available in all dimensions



Can be equipped with automatic role



Stackable



Low-rise stores



High-density stores



Expandable with accessories



Weatherproof



Special design possible



Truck fit



individual adaptation



nested



3 years warranty



Corlette® - Accessories

1. Wire end walls

Gaps can be reduced by using smaller mesh sizes or additional flat bars.

2. Shelves

For insertion as intermediate shelves at one or more levels.

3. Front door

Insertable semi fold-down front door for securing load. Lower half can be flapped up depending on model.

4. Wheel direction lock

Zum fixieren einer Lenkrolle. Geradeauslauf garantiert.



Special dimensions

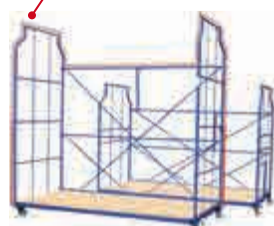

Adapted to customer's application

Double door with locking mechanism



Shelf hooks

Permit shelf insertion at points where there is no round tube.



Stacking limiter

Not in combination with PVC protective clip



Thread guard



Universal Corlette

5. Coating

Nearly all RAL shades available on request. Colour can be applied as single component paint or as powder coating. Electro-galvanising or hot-dip galvanising also available on request.



Coating 5.

Labelling elements 6.

6. Labelling elements e.g.

Aluminium board with blackboard coating, Labelling element for EAN+ barcode in storage management system. Metal pocket and labelling pocket



7. Base panel

- chipboard
- plywoo
- film coated
- screen printed
- ESD panel
- OSB boar
- medium-density fibreboard (MDF)
- plastic

8. Thread guard

Minimises uptake of threads from floor.

Base panel 7.

Base frame

U-section with integrated stack claws (for Universal Corlette)



Front door 3.

Corlette® - Accessories

1. Side hook
For fitting load securing tube / front doors to a Corlette.

2. Securing strap
For securing goods in any desired position on the Corlette, even if not fully loaded. Flexible, tear-proof, UV resistant. One end looped in place, other end with hook; also hook / hook. Textile or rubber.

3. Load securing tube
Dual use: can be inserted as support tube or as load securing tube for closing the open side.



4. Double-wall sheets
For lining the ends and back to protect the goods, and to prevent small items falling out.

5. Base panel
Also wire mesh or perforated sheet, allows water to pass through if necessary e.g. rain or fire-fighting water.



6. Auto-twist castor
It is the auto-twist castor that makes it possible to insert a Corlette in a pallet rack. See Chapter A Info 1.20



7. Coupling / drawbar
For towing one or more units. Retaining devices, various types.



With a variety of smart accessories parts that Cordes has been specially developed for the Corlette®, it is even more efficient.

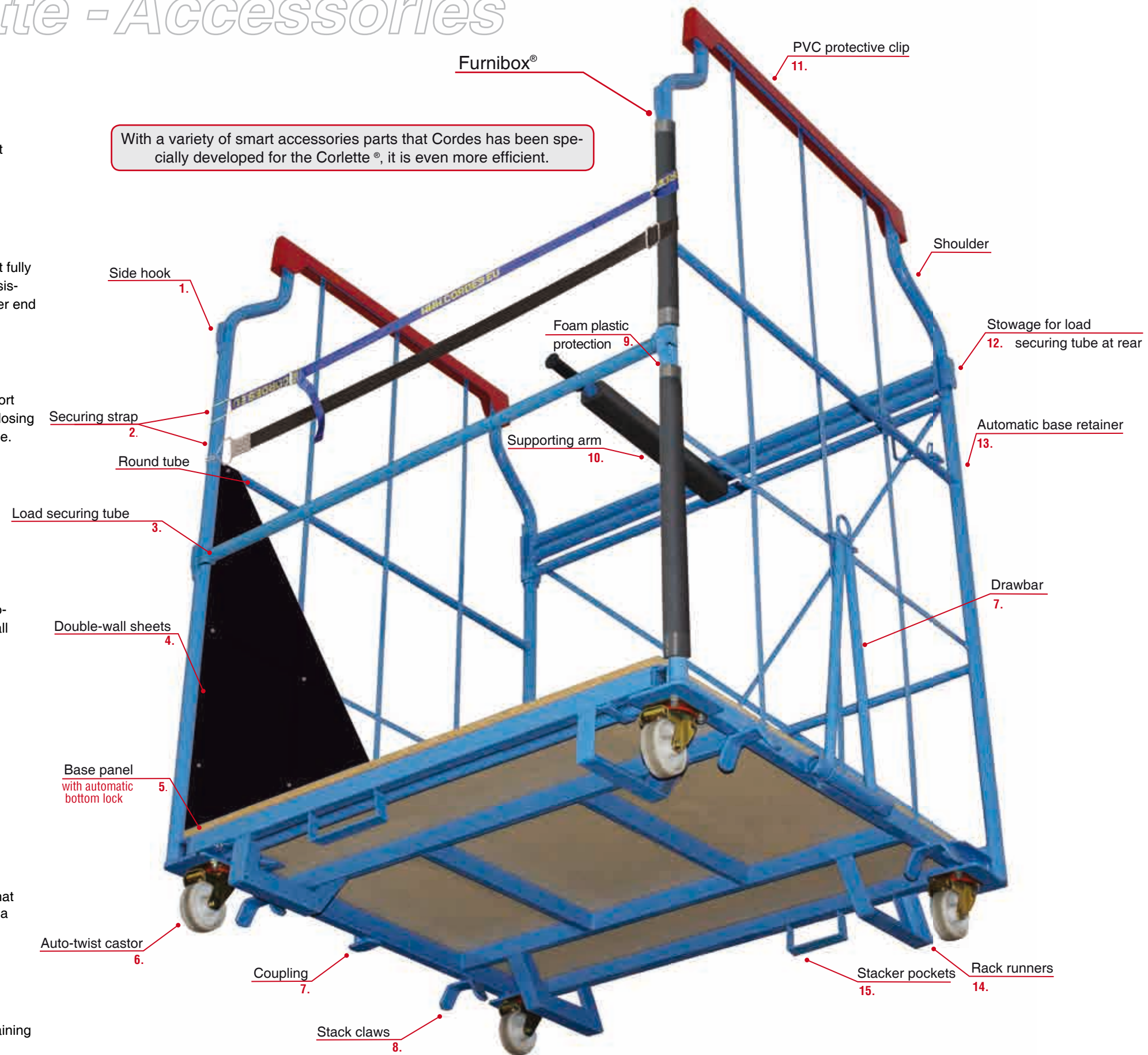

8. Stack claws
These permit secure stacking of Corlettes



9. Foam plastic protection
Easy to fit, easy to change, wherever additional protection is needed.

10. Supporting arm
Four advantages: single-handed operation from the front, optimum protection of goods, can be used on both sides, retrofitting also possible.



11. PVC protective clip
Perfect protection for long items leaning on sides.



12. Stowage for load securing tube at rear
Safe and simple storage when not in use.

13. Automatic base retainer
Automatically holds base when flapped up..



14. Rack runners
Requirement for stacking in Corlette or pallet racks. Continuous or split. Also possible in side wall.



15. Stacker pockets
The diagonally staggered stacker pockets permit trouble-free handling by fork-lift truck.

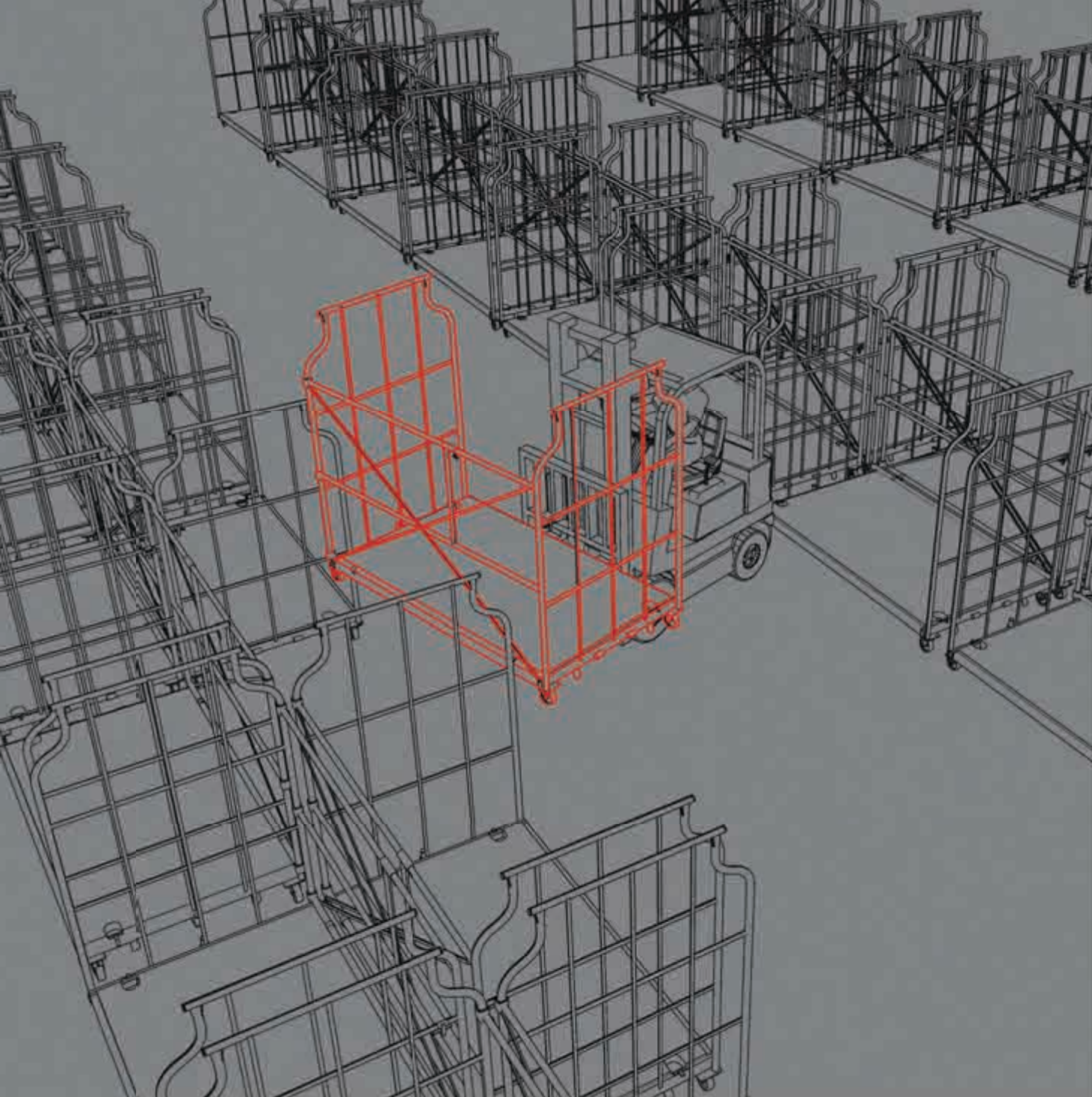

Low-rise stores

**Fast moving.
No more reloading.
The Corlette®.**

The Corlette® creates space and organisation in low-rise stores and also ensures that items which belong together stay together. It goes without saying that the Corlette® is quick and easy to move with all towing vehicles in common use.

The Corlette® keeps your orders together from start to finish. And with its easy-running wheels the Corlette also guarantees speedy transport within your store, whether manually or with electric towing vehicles. That way you can make full use of your storage space and still have speedy access to goods "in the farthest corner".



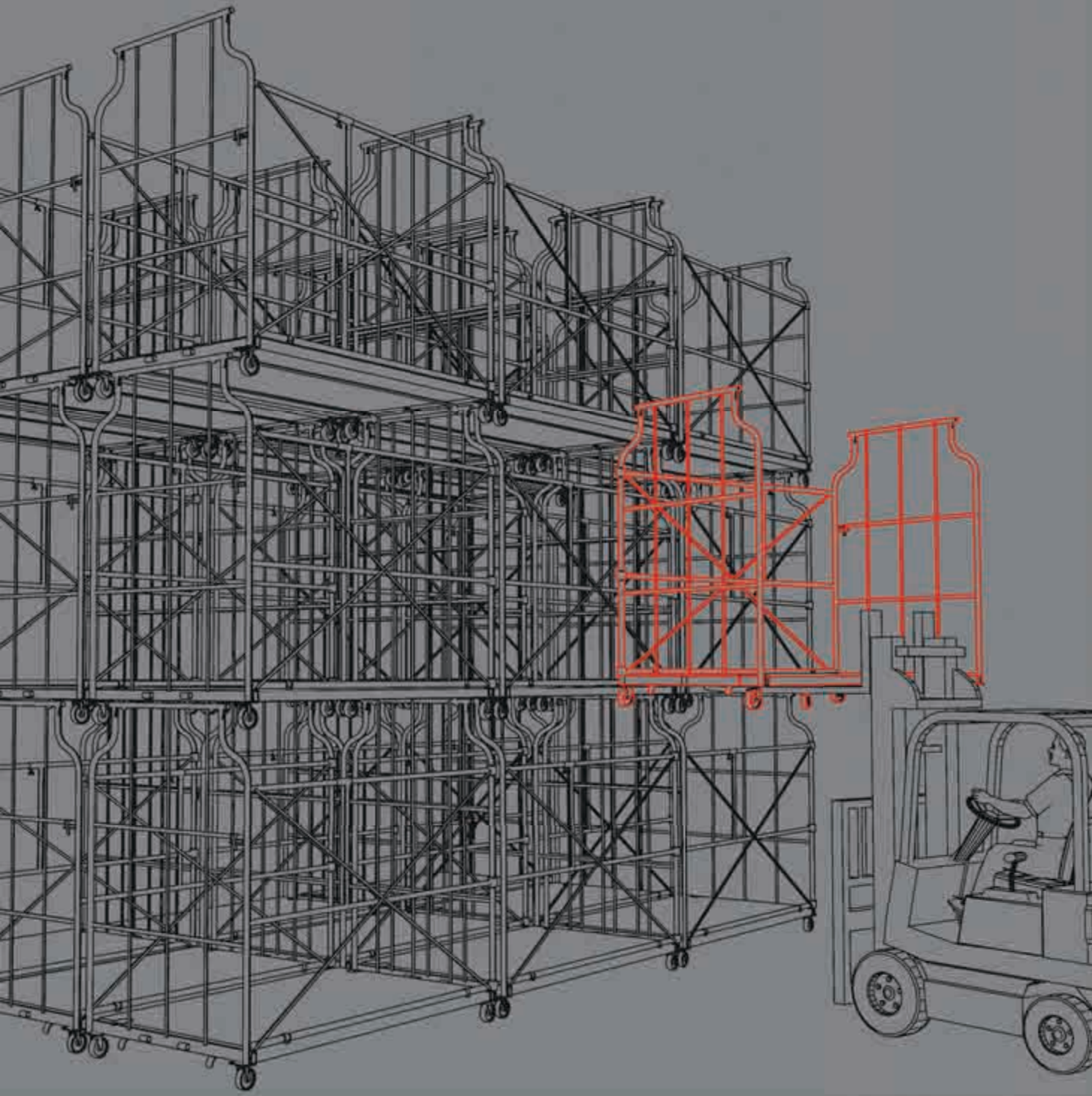

High-density stores

**Stack high.
Gain space.
The Corlette®.**

The Corlette® enables you to double or even treble your storage capacity without having to rent a single extra square metre. In a high-density store that's really easy and quite affordable.

Simply use a normal fork-lift truck to stack the Corlettes® two or three high, and use the height of your store to the full. And the best of it is that with the Corlette® you can reduce movements for seasonal and mass goods and store even more on the same space.

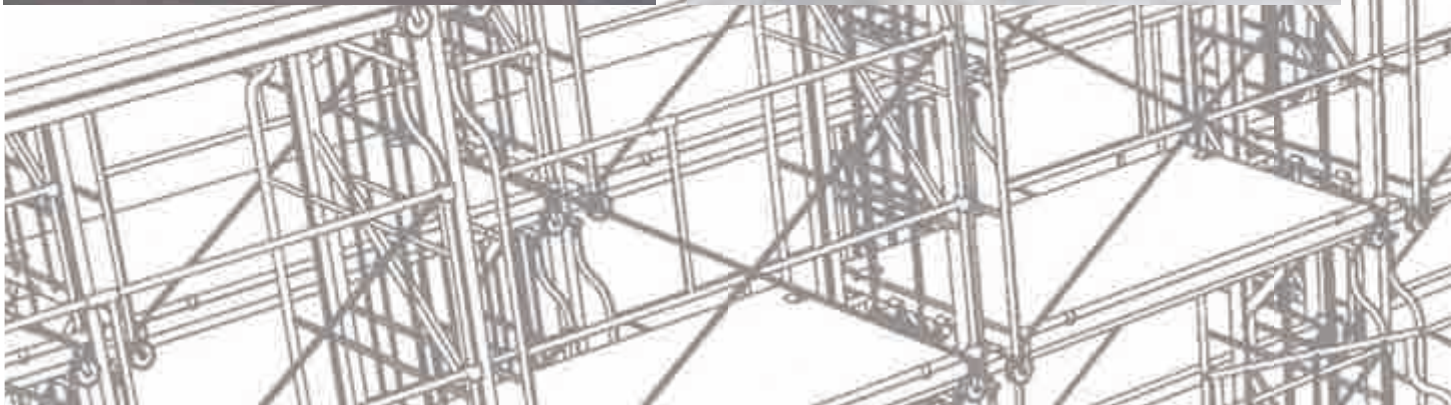

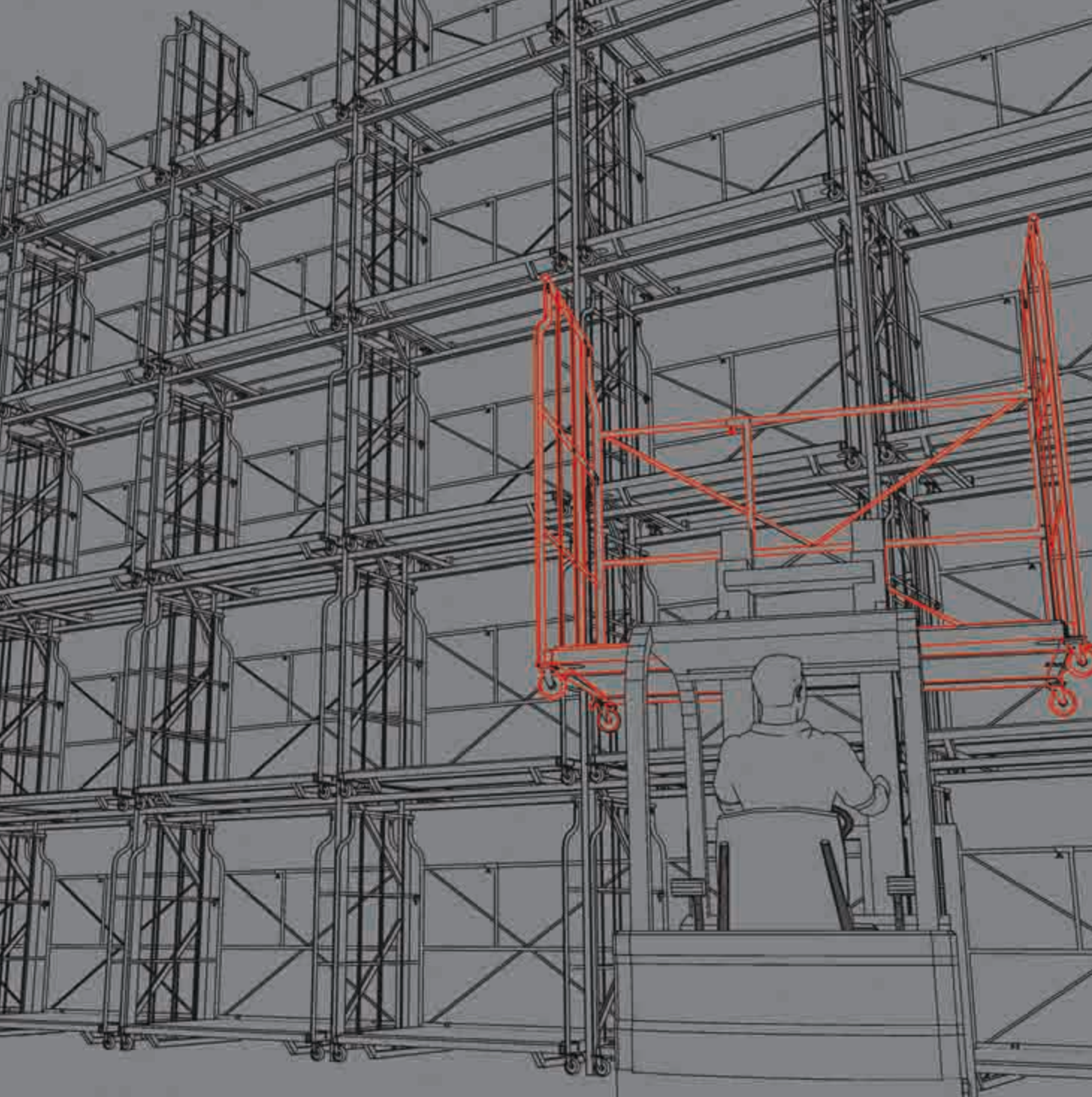

Rack stores

**Direct access.
Even to the very top.
The Corlette®.**

High, higher, highest! The Corlette® gives you speedy direct access to your products, regardless of what level they are in your pallet rack store. A particularly practical feature is that you can even use the Corlette® to store items of furniture that project upwards, allowing you to keep even unwieldy items well protected and available at all times.

Time for combinations! Of course the Corlette® rack is not the only rack the Corlette® fits into. The Corlette® can also be used in pallet racks and offers perfect protection to mixed goods.

The auto-twist castor was developed for this purpose and can also be retrofitted to any Corlette®. The Corlette® is so flexible.

The Corlette® is particularly suitable for narrow-aisle trucks – aisles can be as little as 1.80 m wide. And with order-picking stackers you can conveniently go to the desired rack positions with an empty Corlette, remove individual goods stored there and safely transport them further.

In this way you can use your rack compartments efficiently to store large quantities of products, but still remove them rapidly when needed.

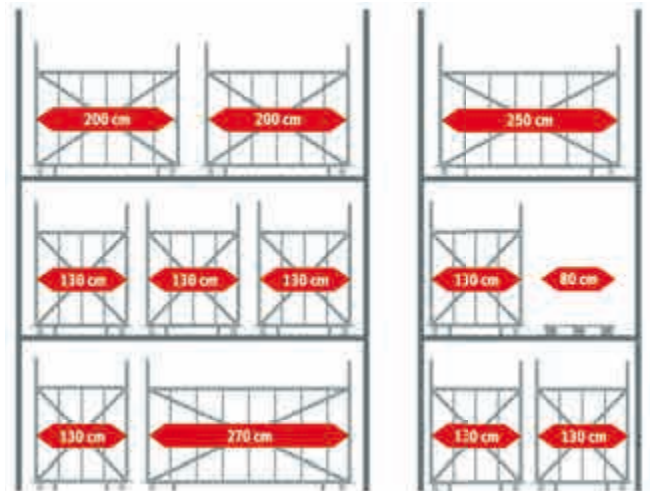

Corlette® - rack
(width 4300 mm, depth 780 mm)

Pallet-rack
(width 2700 mm, depth 1100 mm)

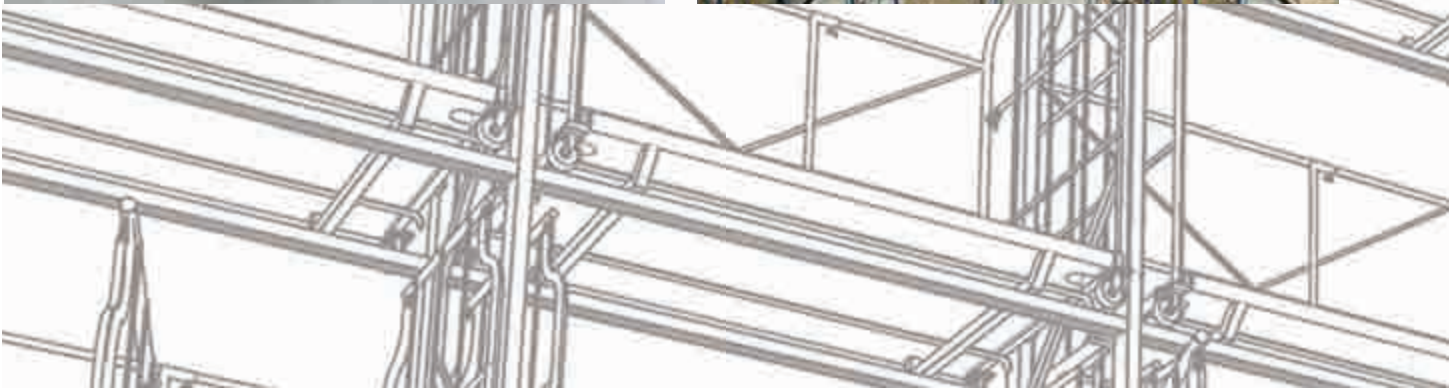

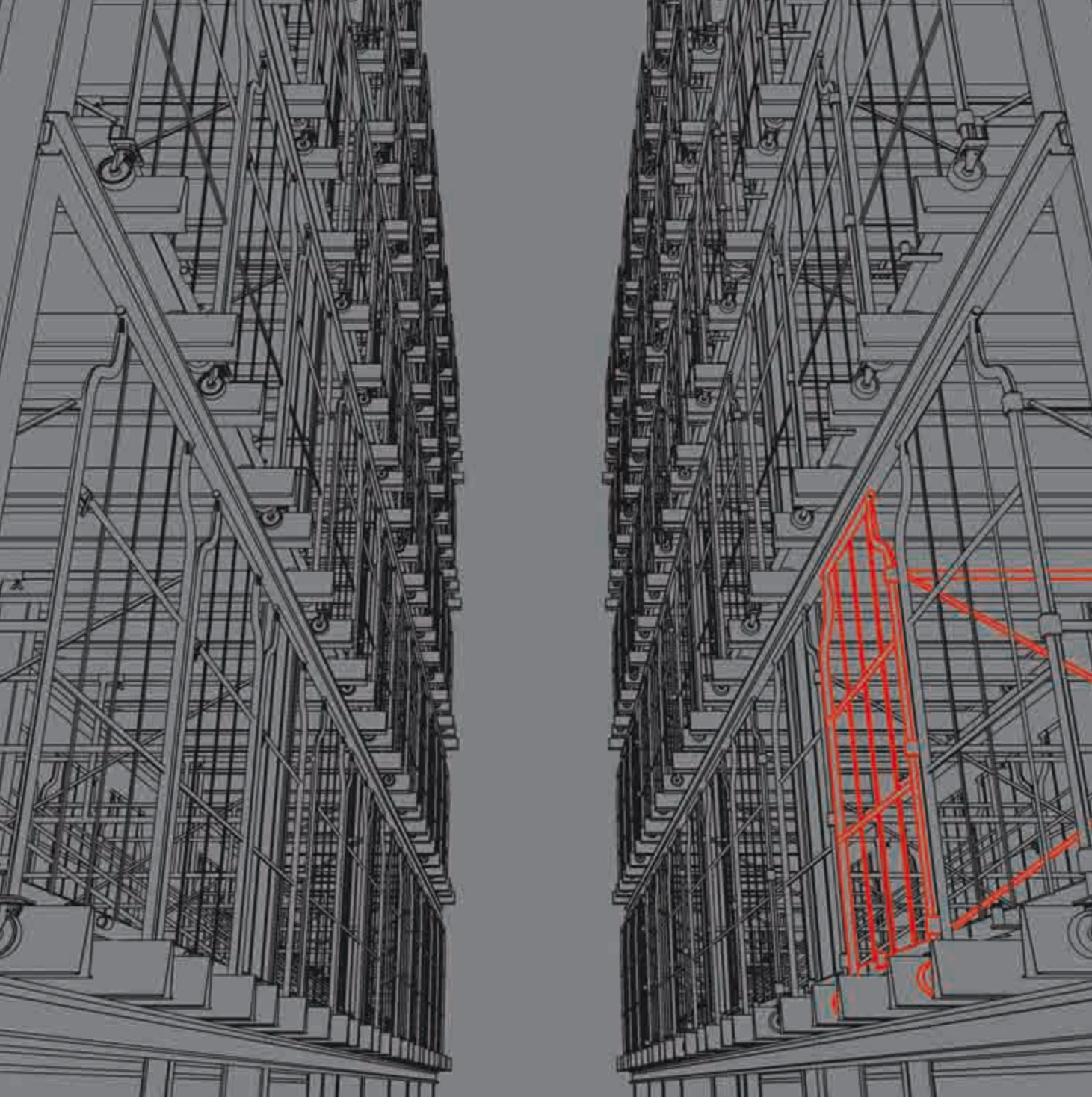

Fully automated high-rise stores

In use everywhere. Always safe. The Corlette®.

The Corlette® is perfect for modern computer-controlled high-rise stores: you can make hundreds of inward and outward movements per day without major personnel requirements if you use the Corlette® in your high-rise pallet store.

Quite apart from speed and efficiency, the Corlette® provides protection for your goods even at great heights (e.g. 47 metres). So you can keep your complaints rate low even if your products reach great heights.

Since the Corlette® makes for safe and trouble-free automatic reloading, it is a must for every high-rise pallet store.



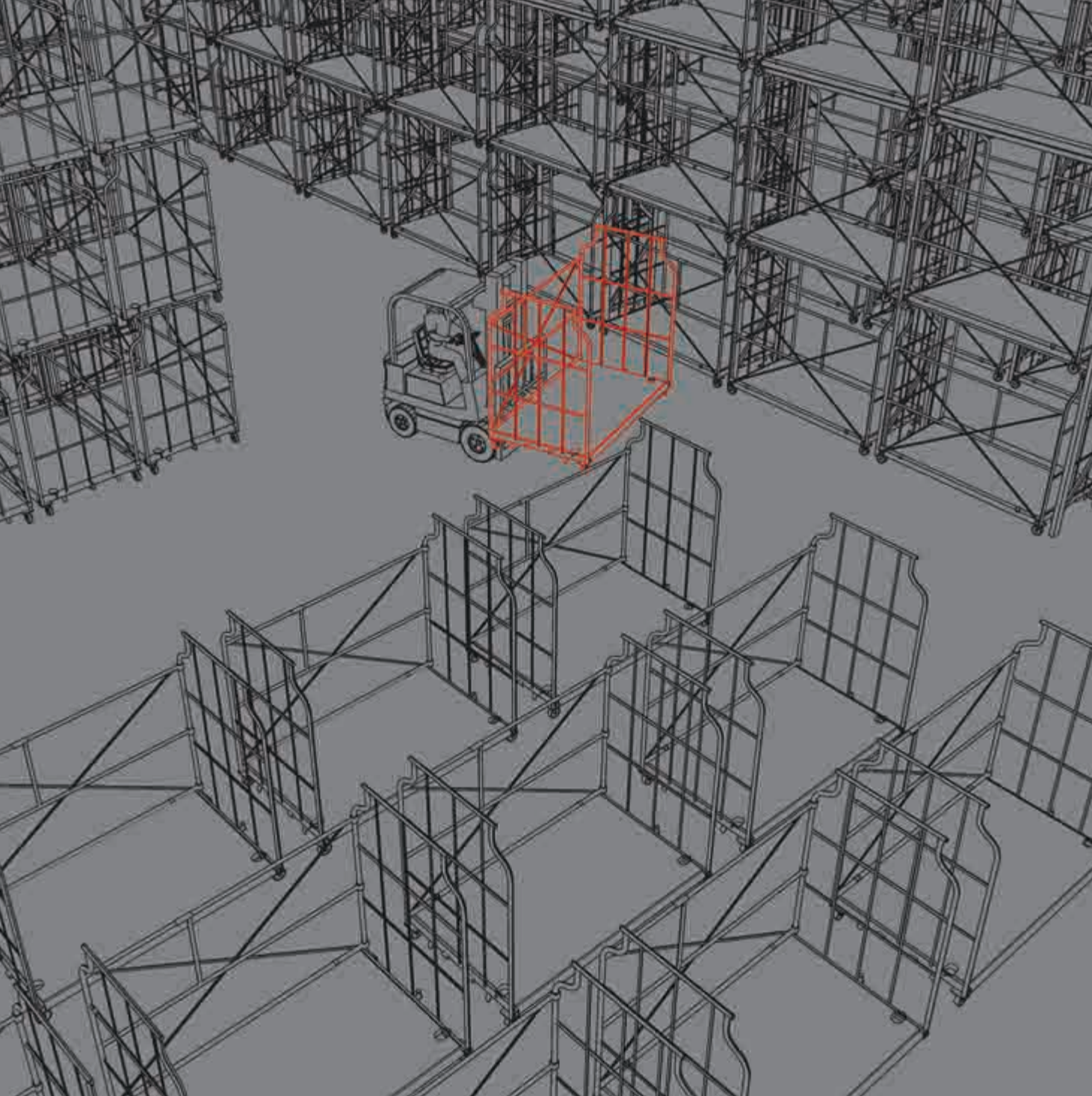

Combined stores

**Move fast.
Stack high.
The Corlette®.**

How often do you have to flexibly adapt the storage situation in your combined store to cope with shifts in the range and seasonal fluctuations? Large orders come in and others have to be shifted aside or stored for longer periods. In other words, situations where lots of labour is needed to reorganise the goods and the risk of damage increases.

It's easier and safer with the Corlette®. With its easy-running wheels the Corlette® can move around low-rise stores quickly and without much effort: a single worker can move up to 1000 kg manually with the Corlette®. When stacked they offer massive spare space for peak times, and in the rack they ensure rapid access to the goods at all times.

And your Complaints Department will be delighted that the Corlette® protects your products like a safe even when things get hectic.

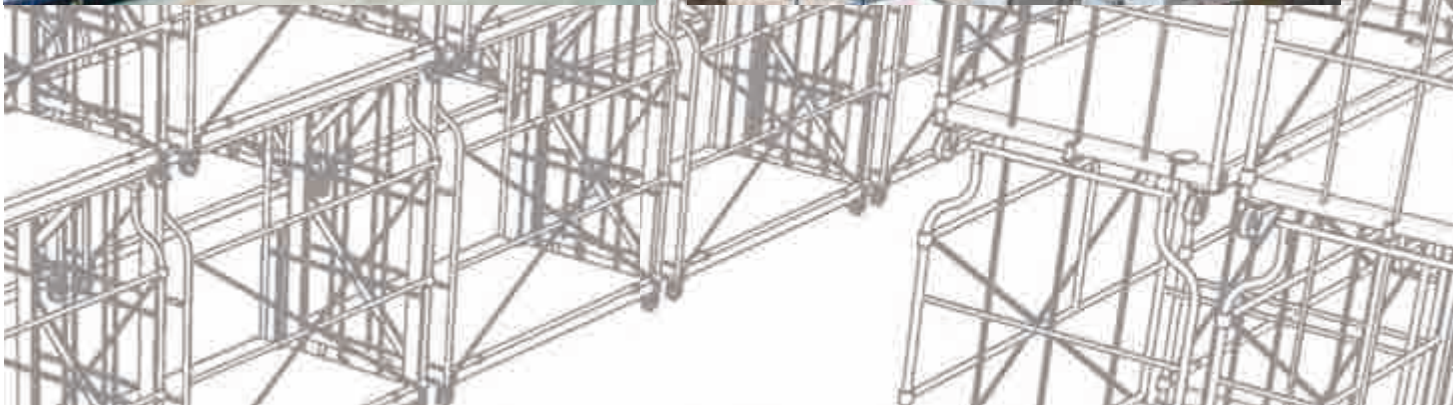

Examples of use



Transport and removal from the end



Examples of use



Corlette® in Low-rise store



Examples of use

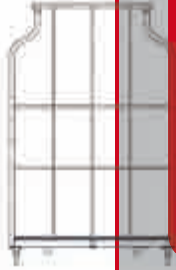

Corlette®

Examples of use



3 high stacking



Dolly

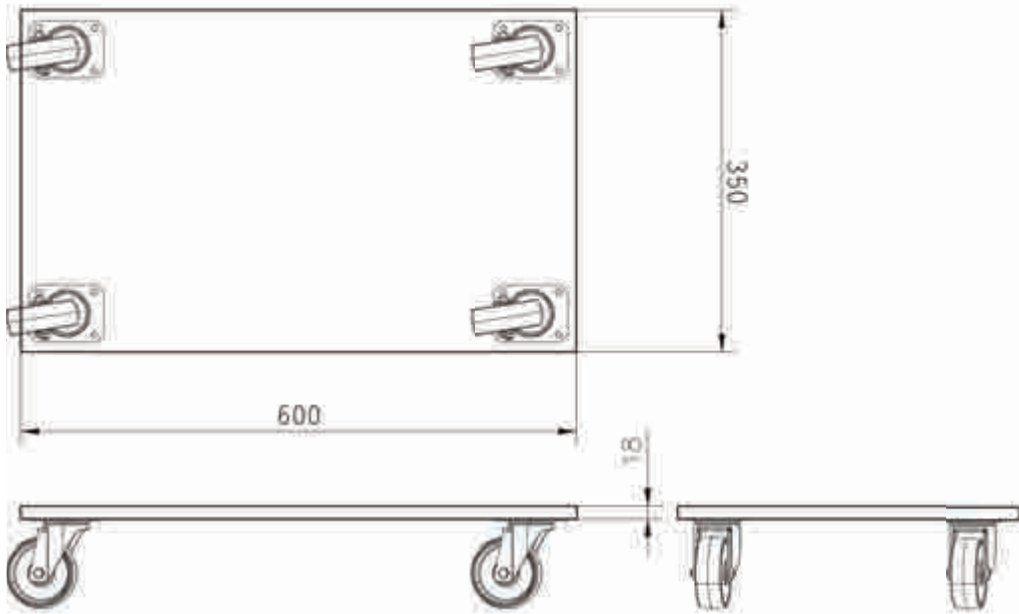

Dolly

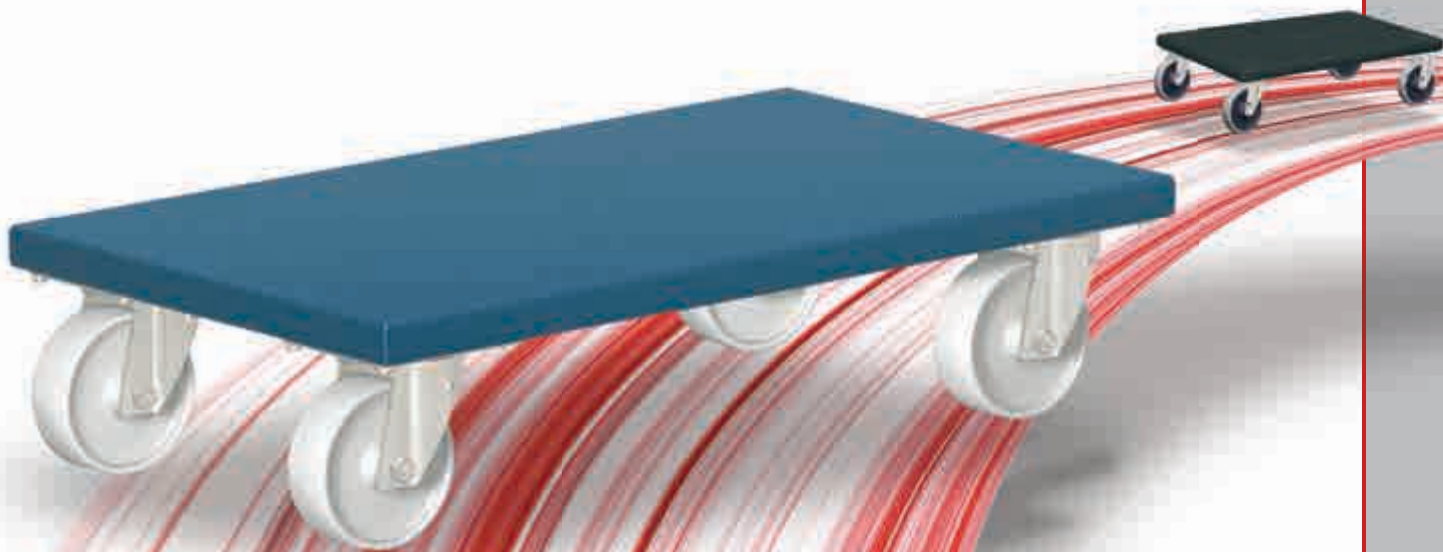

Dolly

Dolly



Dolly

Dolly with non-slip surface and 4 swivel castors with plastic or solid-rubber, grey non-marking wheels with roller bearings, or thermoplastic rubber tyres with precision deep-groove ball bearings.

Dolly
with plastic swivel castors



Dolly

Article. No.	Dimensions	Load surface	Weight	Load cap.	Wheel diam.
	W / D / H mm	w / d mm	kg	kg	mm
mh-934.003	600 / 350 / 145	600 / 350	5,0	500	100
mh-938.000	600 / 350 / 175	600 / 350	6,5	500	125
mh-951.013	600 / 350 / 145	600 / 350	5,5	500	100

Dolly
with plastic swivel castors



Dolly

Article. No.	Dimensions	Load surface	Weight	Load cap.	Wheel diam.
	W / D / H mm	w / d mm	kg	kg	mm
mh-935.003	600 / 350 / 145	600 / 350	5,0	300	100
mh-939.000	600 / 350 / 175	600 / 350	7,0	300	125
mh-935.020	600 / 350 / 145	600 / 350	5,5	300	100

Dolly
with rubber swivel castors



Dolly

Article. No.	Dimensions	Load surface	Weight	Load cap.	Wheel diam.
	W / D / H mm	w / d mm	kg	kg	mm
mh-949.050	600 / 350 / 145	600 / 350	5,5	300	100
mh-959.050	600 / 350 / 175	600 / 350	6,5	300	125
mh-949.051	600 / 350 / 145	600 / 350	5,0	300	100

Dollies available on request in special sizes and variants.



Available in all dimensions



Special design possible



individual adaptation



3 years warranty

Dolly

Dolly

Europa Dolly, of multiplex plywood with rubber buffer surround as additional collision protection for walls and doors. 4 swivel castors with plastic or solid-rubber tyres, grey non-marking with roller bearings, or thermoplastic rubber tyres with precision deep-groove ball bearings.



Available in all dimensions



Special design possible



individual adaptation



3 years warranty

Dolly - Europa
with plastic swivel castors



Dolly - Europa

Article. No.	Dimensions	Ladefläche	Weight	Load cap.	Wheel diam.
	W / D / H mm	w / d mm			
with plastic swivel castors					
mh-936.003	600 / 350 / 145	600 / 350	5,5	500	100
with thermoplastic tyres (no picture)					
mh-949.300	600 / 350 / 145	600 / 350	6,0	300	100
with rubber swivel castors (no picture)					
mh-937.003	600 / 350 / 145	600 / 350	6,5	300	100

Dolly - Europa
for 600mm x 300mm und 600mm x 350mm



Robust steel tube construction. For approx. 40 dollies measuring 600 x 300 mm or 600 x 350 mm. Powder-coated RAL 5012 light blue, permanent surface protection, impact-resistant and scratch-resistant. With four 125 mm plastic swivel castors.

Article. No. mh-942.500

Dimensions	Weight	Load cap.	Wheel diam.	Stackable
W / D / H mm	kg	kg	mm	
700 / 720 / 2000	22,0	250	125	-
Internal dimensions				
Dolly				
40x				

Dolly collector with special dimensions on request



Upholstered suite trolley

These trolleys for upholstered suites or elements permit elegant and easy movement to any desired position. Despite their light weight, they are made of robust steel tube and designed specially for upholstered furniture. The pull-out bars are galvanised and continuously retractable. So they can adjust to the individual upholstered load.

Upholstered suite trolley

1 Level



Article. No. **pg-913.500**

Dimensions	Weight	Load cap.	Support cap.	Stackable	Wheel diam.
W / D / H mm	kg	kg	kg		mm
2800 / 1100 / 1260	26	300	-	-	100
Internal dimensions					
w / d / h mm					
2200 / 700 / 920					

Load surface height: 280 mm, wheels 100 mm rubber, non-marking,
Intermediate shelf height 920 mm
Colour: Light blue RAL 5012
Wheels: 4 x 100 mm non-marking rubber swivel castors

Upholstered suite trolley

2 Levels



Article. No. **pe-911.500**

Dimensions	Weight	Load cap.	Support cap.	Stackable	Wheel diam.
W / D / H mm	kg	kg	kg		mm
2800 / 1100 / 1260	36	300	-	-	100
Internal dimensions					
w / d / h mm					
2200 / 700 / 920					

Load surface height: 380 mm, wheels 100 mm rubber, non-marking,
Intermediate shelf height 920 mm
Colour: Light blue RAL 5012
Wheels: 4 x 100 mm non-marking rubber swivel castors

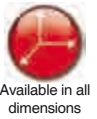

Available in all dimensions



Expandable with accessories



Special design possible



individual adaptation



nested



3 years warranty

Dolly



Upholstered element trolley



Available in all dimensions



Expandable with accessories



Special design possible



individual adaptation



nested



3 years warranty

Upholstered element trolley

3 Levels



Article. No. **pe-915.001**

Dimensions W / D / H mm	Weight kg	Load cap. kg	Support cap. kg	Stackable	Wheel diam. mm
3100 / 894 / 1850	62	300	-	-	100
Internal dimensions w / d / h mm					
2400 / 860 / 1850					

Load surface height: 320 mm, wheels 100 mm rubber, non-marking,

Intermediate shelf height 730 mm

Colour: Light blue RAL 5012

Wheels: 4 x 100 mm non-marking rubber swivel castors

Upholstered element trolley

nested



Empty upholstered element trolleys can be nested to save space. The pull-out bars are galvanised and continuously retractable, enabling the support area to be adjusted to the individual element.



Bedroom box

Space saving is the paramount criterion for the bedroom box. Its small depth permits safe storage and order-picking of furniture of little depth. When not in use this handling appliance can also be folded up in next to no time.

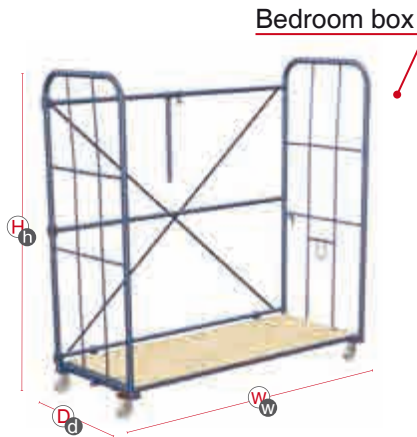

Bedroom box

Article No. **sb-920.500**

Dimensions	Weight	Load cap.	Support cap.	Stackable	Wheel diam.
W / D / H mm	kg	kg	kg		mm
1730 / 730 / 1730	60	600	-	-	100
Internal dimensions					
w / d / h mm					
1675 / 685 / 1545					

Load surface height: 190 mm, underclearance: 125 mm

Colour: Light blue RAL 5012

Wheels: 4 x 100 mm plastic swivel castors, one with wheel direction lock



Bedroom box
nested

The bedroom box can be nested when empty. This brings a space saving of 70%. A stopper prevents the base from flapping back. So the bedroom box takes up little space when kept in the store ready for use.

 accessories in
Chapter A 4.10



Available in all dimensions



Expandable with accessories



Special design possible



individual adaptation



nested



3 years warranty



Examples of use

Dolly



Transport container

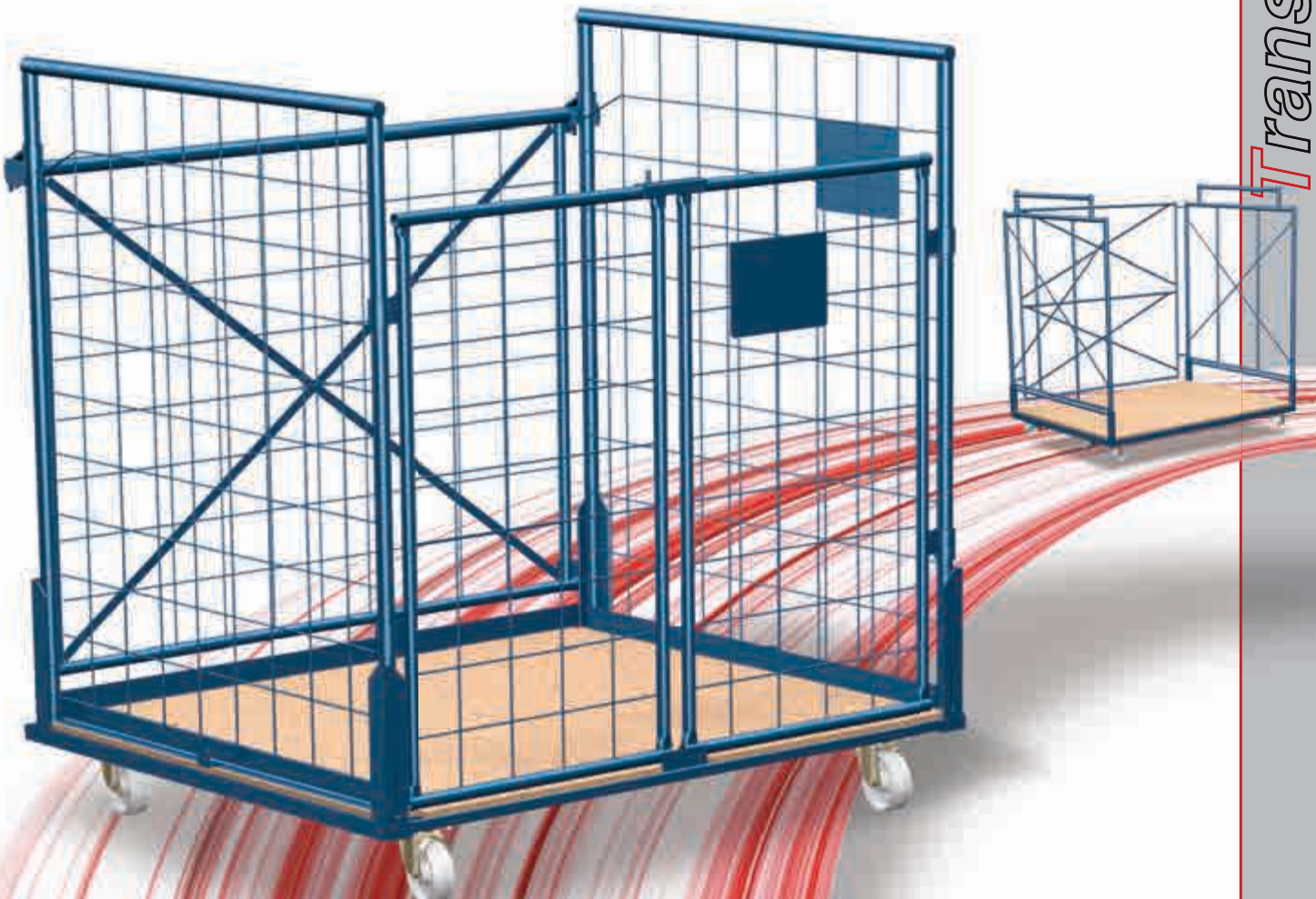
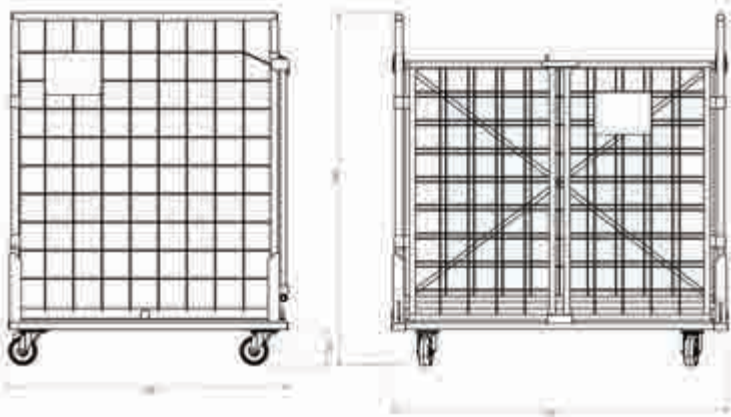
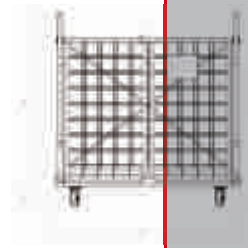

Transport container

Transport container

Transport container



Quadro-Corlette®

The Quadro-Corlette® ensures ideal space utilisation, especially in truck transhipment. Two Quadro-Corlettes will fit side by side on a truck, stacked two high. This makes optimum use of the space available.

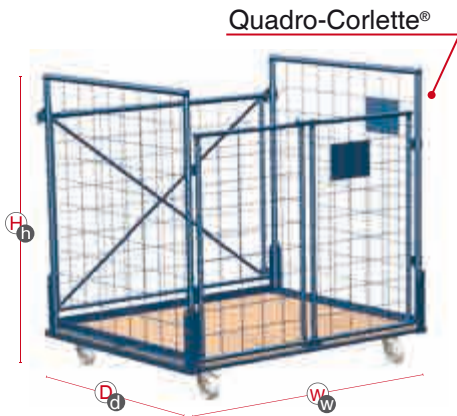
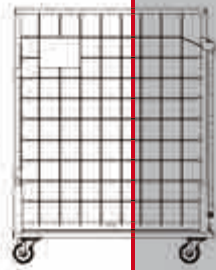

Quadro-Corlette®

Article. No. **sp-120.513**

Dimensions W / D / H mm	Weight kg	Load cap. kg	Support cap. kg	Stackable	Wheel diam. mm
1200 / 1000 / 1250					
Internal dimensions w / d / h mm	57	500	300	2 high	100
1100 / 920 / 1080					

Load surface height: 165 mm, underclearance 130 mm, mesh size: 100 x 100 mm
Colour: Light blue RAL 5012
Wheels: 4 x 100 mm plastic swivel castors

Quadro-Corlette®
8 x nested



ca. 2150 mm

Two stacks of empty Quadro-Corlettes fit side by side into a truck, each stack 8 high. This means you need only one metre of load space length for 16 units. When loaded, the same area can accommodate 4 units.



Available in all dimensions



Stackable



Low-rise stores



High-density stores



Expandable with accessories



Special design possible



Truck fit



individual adaptation



Verdichtung durch Klappbare Seitenwände



3 years warranty

Transport container



64 units stacked on less than half a truck.

Corlettine



Available in all dimensions



Stackable



Low-rise stores



High-density stores



Expandable with accessories



Special design possible



Truck fit



individual adaptation



Verdictung durch Klappbare Seitenwände



3 years warranty

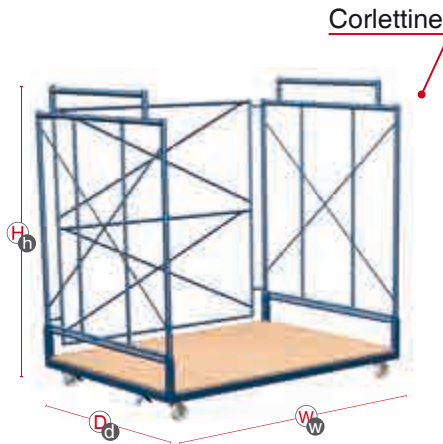

Article. No. **sp-180.000**

Dimensions	Weight	Load cap.	Support cap.	Stackable	Wheel diam.
W / D / H mm					
1800 / 1300 / 1810					
Internal dimensions	102	500	500	3 high	100
w / d / h mm					
1670 / 1270 / 1610					

Load surface height: 200 mm, underclearance: 130 mm

Colour: Light blue 5012

Wheels: 4 x 100 mm plastic swivel castors

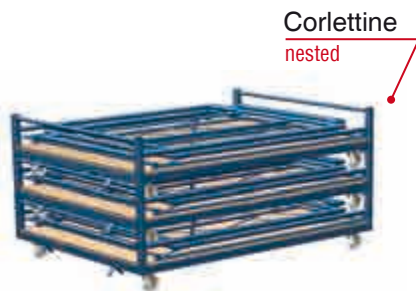

By storing the side walls when empty, the Corlettine is reduced to its basic dimensions. In the folded-up state, the Corlettine can be stored in stacks up to 12 high. Can also be used as a frame with runners (without castors).



accessories in Chapter A 4.10



Bicycle Corlette®

The Bicycle Corlette® is not only stackable like many other Corlettes®, but also has a 5-stage height adjustment. Which means it can take everything from a children's bike to a 28-inch adult bike. You can store up to 10 bicycles in a Bicycle Corlette®.

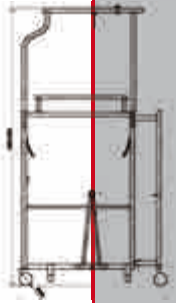

Bicycle Corlette®

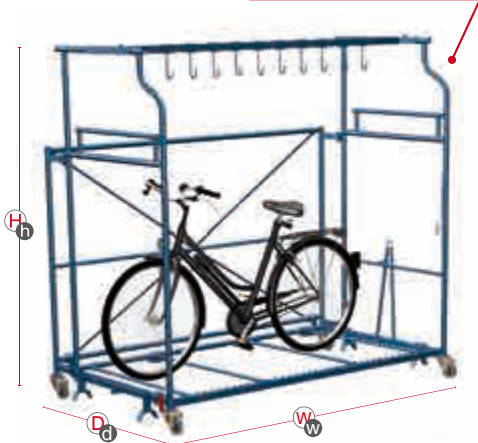

Article. No. **sp-210.003**

Dimensions W / D / H mm	Weight kg	Load cap. kg	Support cap. kg	Stackable	Wheel diam. mm
2100 / 1150 / 1950 - 2200	81	600	600	2 high	100
Internal dimensions w / d / h mm					
1915 / 1110 / 1765 - 2015					

underclearance: 135 mm
 Base with adjustable tubes for adapting to different wheel sizes
 Color: lightblue RAL 5012
 Wheels: 4 x 100 mm elastic solid rubber swivel castors, one with wheel direction lock

Bicycle Corlette®



with **separator tarpaulins**

Dimensions W / D / H mm	Weight kg	Load cap. kg	Support cap. kg	Stackable	Wheel diam. mm
2020 / 1200 / 1950 - 2200	100	600	600	3 high	100

Load surface height: 174 mm, underclearance: 134 mm
 Colour: galvanisch verzinkt
 Wheels: 4 x 100 mm elastic solid rubber swivel castors, one with wheel direction lock



Available in all dimensions



Can be equipped with automatic role



Stackable



Low-rise stores



High-density stores



Expandable with accessories



Special design possible



individual adaptation



nested



3 years warranty

Transport container

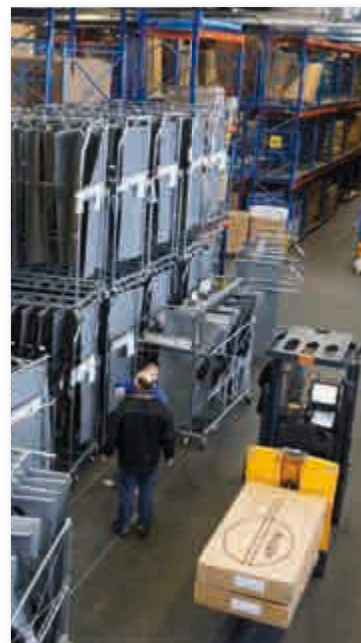

Bicycle logistic



Available in all dimensions



Expandable with accessories



Special design possible



Truck fit



individual adaptation



3 years warranty

Bicycle Corlette®
for 4 suspended bicycles



Bicycle box



Dimensions	Weight	Load cap.	Support cap.	Stackable	Wheel diam.
W / D / H mm	kg	kg	kg		mm
1150 / 1200 / 1950 -2200	83	600	600	3	100

with central brake, operated by hand lever, suitable for trucks, height adjustable
Colour: hot galvanised

Wheels: 4 x 100 mm elastic solid rubber swivel castors, one with wheel direction lock



High-density stores



Stackable



Low-rise stores



nested

Bicycle box

Technical details on request



accessories in
Chapter **A** 4.10

Cordes stacking rack®
with bicycle cartons



Corlette®
with bicycle cartons



Safe Corlette®

In these days of online business, customers want to order from home and have the product in their hands within 24 hours. The parcels have to be transported without delay direct from the sender to the regions via truck and distribution depot. European post and parcel carriers have to face this challenge afresh every day. Increasing numbers of them are already using our Safe Corlette with great success. It protects the parcels from damage during transport in trucks and internal materials handling operations.

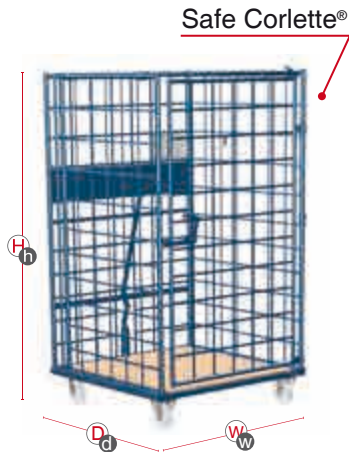

Safe Corlette®

Article. No. **sf-120.500**

Dimensions	Weight	Load cap.	Support cap.	Stackable	Wheel diam.
W / D / H mm					
1200 / 1150 / 2050					
Internal dimensions	124	750	-	-	100
w / d / h mm					
1100 / 1100 / 1840					

Load surface height: 200 mm, underclearance: 135 mm
 Mesh size: 140 x 140 mm,
 Colour: Light blue RAL 5012
 Wheels: 4 x 100 mm plastic swivel castors with thread guard



Safe Corlette®
folded state

Empty Safe Corlettes® can be nested to save space by using the "fold trick".

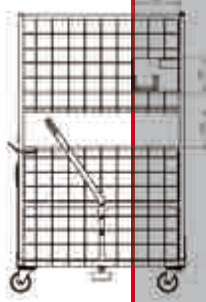

Available in all dimensions



Low-rise stores



Expandable with accessories



Special design possible



Stand



Truck fit



individual adaptation



nested



3 years warranty

Transport container

Safe Corlette®



Available in all dimensions



Low-rise stores



Expandable with accessories



Special design possible



Truck fit



individual adaptation



nested



3 years warranty

Safe Corlette®



Safe Corlette®



Article No. sf-120.520

Dimensions	Weight	Load cap.	Support cap.	Stackable	Wheel diam.
W / D / H mm	kg	kg	kg		mm
1200 / 1100 / 1976					
Internal dimensions	124	600	-	-	140
w / d / h mm					
1108 / 917 / 1713					

Load surface height: 233 mm, underclearance: 183 mm

Mesh size: 50 x 50 mm,

Colour: Light blue RAL 5012

Wheels: 4 x 140 mm elastic solid rubber swivel castors, two with wheel direction lock



accessories in
Chapter A 4.10

Article No. sf-120.022

Dimensions	Weight	Load cap.	Support cap.	Stackable	Wheel diam.
W / D / H mm	kg	kg	kg		mm
1200 / 1150 / 2050					
Internal dimensions	142	750	-	-	100
w / d / h mm					
1100 / 1100 / 1840					

Load surface height: 200 mm, underclearance: 135 mm.

Mesh size: 50 x 50 mm,

Colour: Light blue RAL 5012

Wheels: 4 x 100 mm plastic swivel castors with thread guard



Safe Corlette®

Foldable and collapsible Corlette mit lockable double door. The Corlette has a central foot brake and an automatic drawbar. The two features are interlinked, so the brake is automatically released when a towing vehicle is attached. Other features of this versatile Corlette are a V-drawbar with automatic stay-up and fold-down function and manually releasable wheel direction locks on both sides which are also automatically released when the door is opened. The base panel is of plywood, film-coated and flush mounted in the frame. When released, the base is automatically raised. The base substructure is designed so that the Corlette can be accessed by stacker from all 4 sides. This Corlette is rounded off by a high-quality durable and resistant two-component paint finish in RAL 5010 gentian blue.

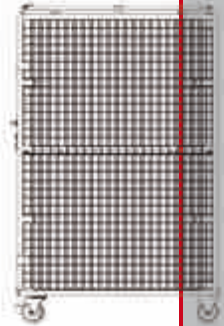

Dimensions	Weight	Load cap.	Support cap.	Stackable	Wheel diam.
W / D / H mm	kg	kg	kg		mm
1200 / 1000 / 1800	152	600	-	-	140
Internal dimensions					
w / d / h mm					
1100 / 930 / 1650					

Load surface height: 240 mm, underclearance: 190 mm. Mesh size: 50 x 50 mm.
 Central foot brake,
 Colour: Gentian blue RAL 5010
 Wheels: 4 x 140 mm easy-running rubber castors with thread guard



Empty Safe Corlettes® can be nested to save space by using the "fold trick".



Available in all dimensions



Low-rise stores



Expandable with accessories



Special design possible



Truck fit



individual adaptation



nested



3 years warranty



Transport container

Safe Corlette®



Available in all dimensions



Low-rise stores



Expandable with accessories



Special design possible



Truck fit



individual adaptation



nested



3 years warranty

Mini-Safe Corlette®
1 intermediate shelf



Mini-Safe Corlette®
3 intermediate shelves



Article No. **ms-080.500**

Dimensions W / D / H mm	Weight kg	Load cap. kg	Support cap. kg	Stackable	Wheel diam. mm
1200 / 800 / 1880					
Internal dimensions w / d / h mm	94	500	-	-	125
720 / 1150 / 1650					

Load surface height: 205 mm, underclearance: 165 mm. Mesh size: 50 x 50 mm.

Colour: Light blue RAL 5012

Wheels: 4 x 125 mm polyurethane castors (96° Shore), 2 fixed castors and 2 swivel castors, including one with wheel brake



accessories in
Chapter A 4.10

Article No. **ms-080.501**

Dimensions W / D / H mm	Weight kg	Load cap. kg	Support cap. kg	Stackable	Wheel diam. mm
1200 / 800 / 1880					
Internal dimensions w / d / h mm	113	500	-	-	125
720 / 1150 / 1650					

Load surface height: 205 mm, underclearance: 165 mm. Mesh size: 50 x 50 mm.

Colour: Light blue RAL 5012

Wheels: 4 x 125 mm polyurethane castors (96° Shore), 2 fixed castors and 2 swivel castors, including one with wheel brake



Safe Corlette®

The Mini and Maxi Safe Corlette® provide secure protection for valuable goods thanks to close-mesh wire sides, a lid and a lockable front door. Like all Corlettes® they can be nested when not in use, and pushed into each other to save space.

Maxi-Safe Corlette®



Article. No. **mx-240.500**

Dimensions W / D / H mm	Weight kg	Load cap. kg	Support cap. kg	Stackable	Wheel diam. mm
2400 / 1150 / 1850	190	750	-	-	125
Internal dimensions w / d / h mm					
2315 / 1070 / 1585					

Load surface height: 205 mm, underclearance: 165 mm, mesh size: 50 x 50 mm.
Colour: Light blue RAL 5012
Wheels: 4 x 125 mm plastic swivel castors, one with wheel direction lock

 accessories in Chapter A 4.10

Maxi-Safe Corlette®
folded state



Like all Corlettes®, the Mini and Maxi Safe Corlettes® can be nested when not in use, and pushed into each other to save space.

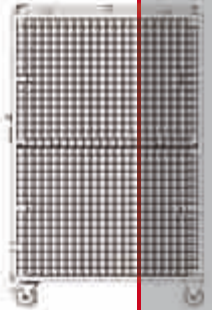

 Available in all dimensions

 Low-rise stores

 Expandable with accessories

 Special design possible

 individual adaptation

 nested

 3 years warranty

Transport container



Letter and parcel trolleys



Available in all dimensions



Expandable with accessories



Special design possible



Truck fit



individual adaptation



3 years warranty

Letter container trolley



Letter container trolley

Technical details on request

Parcel trolley



Parcel trolley

Technical details on request



Examples of use

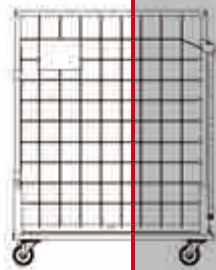

Transport container

Examples of use



Examples of use

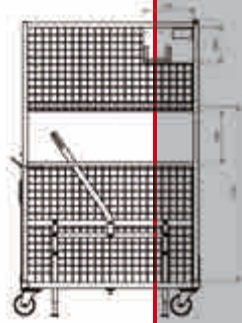

Transport container

Examples of use



Stack racks

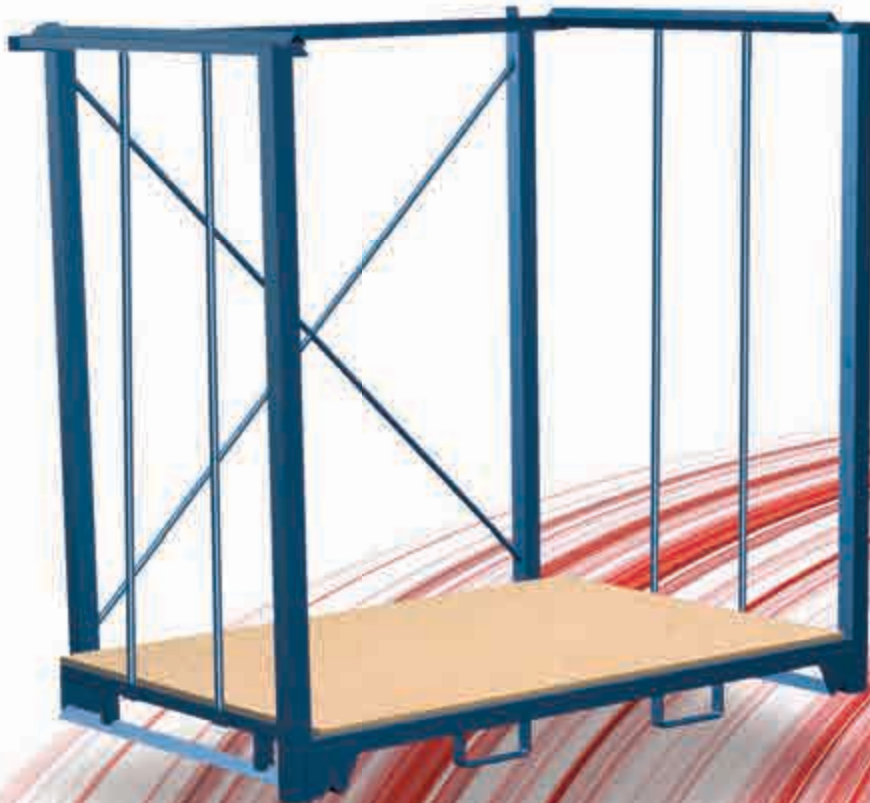
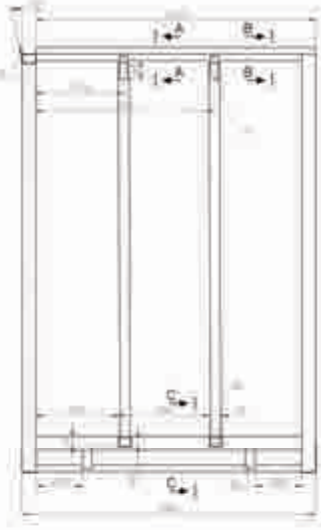
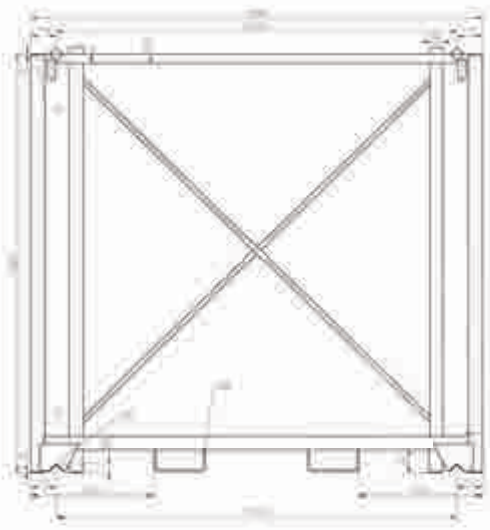

Stack racks

Stack racks

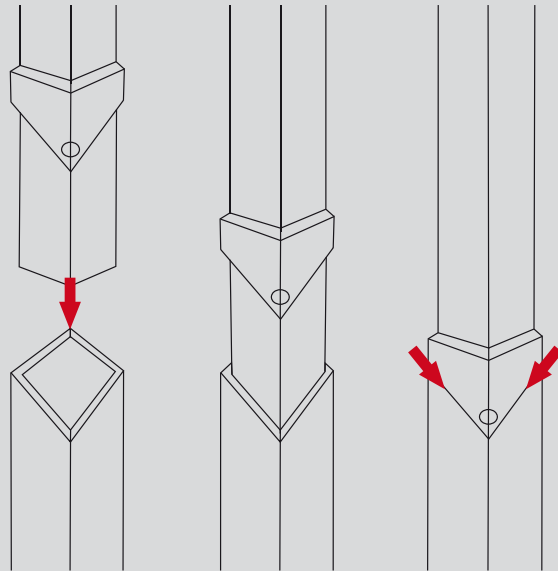
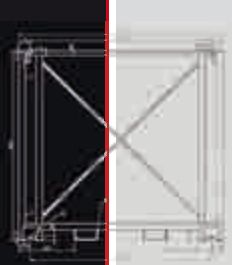

Heavy-duty stacking rack

Stacking racks of various kinds are used for loads of 1000 kg upwards. Stable despite heavy weights, flexible for high-density storage without loss of space for aisles. Stacking racks are easy to adjust to your products and their fluctuating quantities (e.g. seasonal products). And they can take you to great heights – in stacks of up to 5 units. When not in use, our stacking racks can be reduced to 20% of their original volume.

Heavy-duty stacking rack



Heavy-duty stacking rack nested



Article. No. **sl-150.500**

Dimensions W / D / H mm	Weight kg	Load cap. kg	Support cap. kg	Stackable
1500 / 1050 / 2000	95	1000	2400	4 high
Internal dimensions w / d / h mm				
1380 / 930 / 1700				

Load surface height: 165 mm, underclearance: 95 mm, usable height: 1700 mm, 4 loose posts and 3 transverse tubes to stabilise frame.

Thanks to the special design, the racks can stand safely side by side to save space.

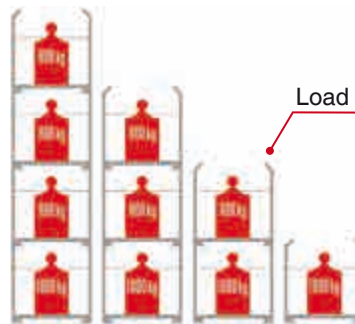

Load example

When empty, the heavy-duty stacking racks can be dismantled and stacked to save space.

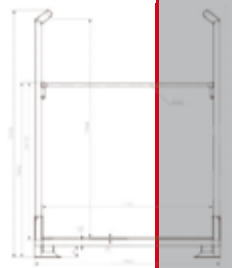

Available in all dimensions



Stackable



Low-rise stores



High-density stores



Expandable with accessories



closed by detachable side walls



Special design possible



individual adaptation



3 years warranty

Stack racks



Heavy-duty stacking rack



Available in all dimensions



Stackable



Low-rise stores



High-density stores



Expandable with accessories



closed by drop-down side walls



Special design possible



individual adaptation



3 years warranty

Heavy-duty stacking rack
sack packing



Heavy-duty stacking rack
nested

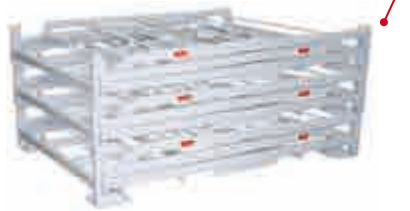

Article. No. **sl-199.510**

Dimensions	Weight	Load cap.	Support cap.	Stackable
W / D / H mm	kg	kg	kg	
1195 / 1475 / 1855				
Internal dimensions	122	1200	5000	5 high
w / d / h mm				
1875 / 1475 / 1650				

Load surface height: 165 mm, underclearance: 95 mm, usable height: 1700 mm, 4 loose posts and 3 transverse tubes to stabilise frame.

Thanks to the special design, the racks can stand safely side by side to save space.

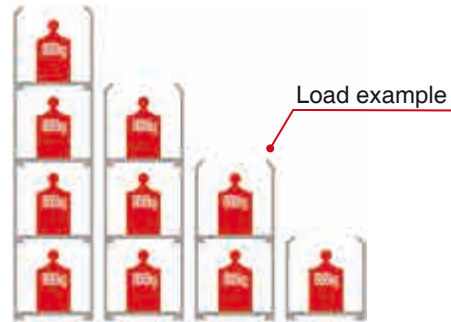

When empty, the heavy-duty stacking racks can be dismantled and stacked to save space.



Tyre stacking rack

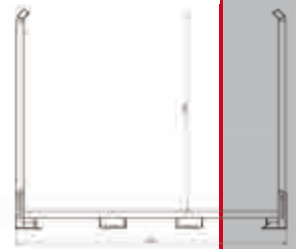

Stability ensured by robust square tubular construction with foldable sides. Variable insertion of support tubes permits two levels of upright storage of tyres mounted on wheels. The benefit: extra large stacking feet simplify accurate stacking. These racks also create more space in your store by stacking 4 high. Robust design ensures the necessary stability. A wide variety of tyre types can be stored in the racks.

Tyre stacking rack
up to wheel diam. 690 mm

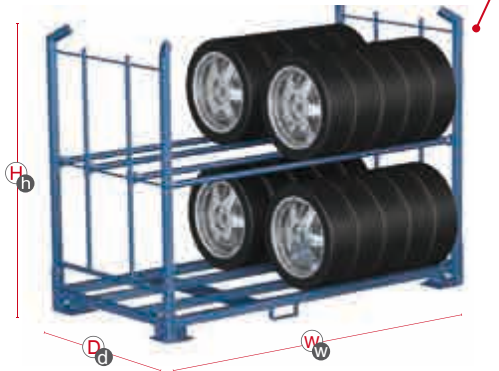

Article No. **sl-240.002**

Dimensions W / D / H mm	Weight kg	Load cap. kg	Support cap. kg	Stackable
2400 / 1200 / 1800	124	800	3500	4 high
Internal dimensions w / d / h mm				
2290 / 1200 / 1575				

Load surface height: 155 mm, underclearance: 95 mm.
Colour: Light blue RAL 5012

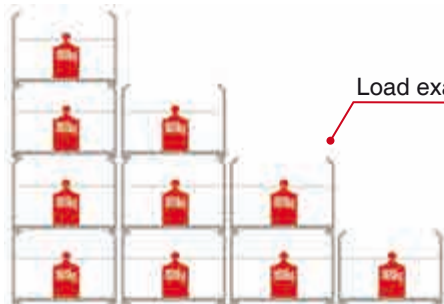

Load example

Tyre stacking rack



Article No. **sl-240.503**

Dimensions W / D / H mm	Weight kg	Load cap. kg	Support cap. kg	Stackable
2330 / 1180 / 2180	168	1000	3000	4 high
Internal dimensions w / d / h mm				
2195 / 1180 / 1960				

Load surface height: 155 mm, underclearance: 95 mm.
Colour: Emerald green RAL 600

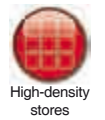

Stack racks



Stanchion stacking rack

Stanchion stacking racks take all the heavy loads off your hands. Ideal for high-density stores, they can ensure organised storage of any kind of product. Robust tubular steel frame construction.



Available in all dimensions



Stackable



Low-rise stores



High-density stores



Expandable with accessories



closed by detachable side walls



Special design possible



individual adaptation



3 years warranty

Stanchion stacking rack



Stanchion stacking rack nested



Article. No. **sl-110.000**

Dimensions W / D / H mm	Weight kg	Load cap. kg	Support cap. kg	Stackable
1100 / 1147 / 1740	64	1500	4700	4 high
Internal dimensions w / d / h mm				
870 / 917 / 1530				

Space saving by means of 4 insertable stanchions.
Special designs and individual modifications possible.
Colour: Light blue RAL 5012

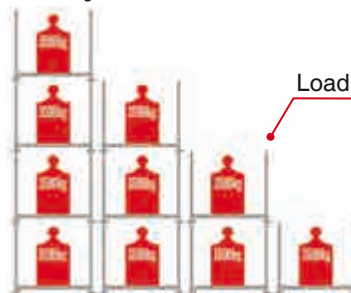

Load example

Article. No. **sl-118.000**

Dimensions W / D / H mm	Weight kg	Load cap. kg	Support cap. kg	Stackable
1185 / 1550 / 1740	71	1500	4700	4 high
Internal dimensions w / d / h mm				
955 / 1320 / 1530				

Space saving by means of 4 insertable stanchions.
Special designs and individual modifications possible.
Colour: Light blue RAL 5012

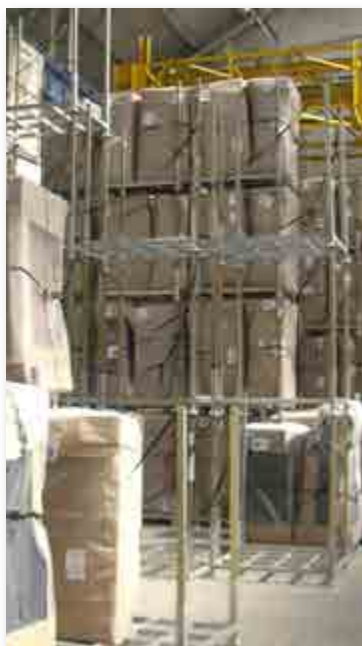

Heavy-duty Container

Heavy-duty Containers can carry loads of up to 1.6 tonnes and are stackable up to 4 high. Suitable for storing Euro-pallets, cartons, sacks or other piece goods. Despite the firmly welded construction of the Container, it can be nested to save space. When empty, up to 7 units can be nested. Round tubes can be stored at the rear to save space, see Fig. 2.



Article No. **sl-204.000**

Dimensions	Weight	Load cap.	Support cap.	Stackable
W / D / H mm		kg	kg	
1940 / 1260 / 1815				
Internal dimensions	122	1600	4800	4 high
w / d / h mm				
1820 / 1200 / 1580				

Load surface height: 180 mm, underclearance: 105 mm. Stackable when empty thanks to conical design.
Colour: Traffic blue RAL 5017

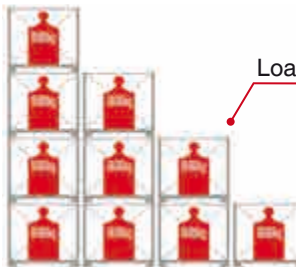

Heavy-duty Container



Article No. **sl-240.006**

Dimensions	Weight	Load cap.	Support cap.	Stackable
W / D / H mm		kg	kg	
2400 / 1260 / 1815				
Internal dimensions	132	1600	4800	4 high
w / d / h mm				
2190 / 1200 / 1580				

Load surface height: 180 mm, underclearance: 105 mm. Stackable when empty thanks to conical design.
Colour: Light blue RAL 5012



CORDES stacking rack

Thanks to 3-high stacking, you can increase your storage area wherever space is available. Up to 3 m high firm, stable and secure. Cordes stacking racks can be moved with most stackers.



Available in all dimensions



Stackable



Low-rise stores



High-density stores



Expandable with accessories



closed by drop-down side walls



Special design possible



individual adaptation



3 years warranty

CORDES stacking rack



Article. No. **cs-120.500**

Dimensions W / D / H mm	Weight kg	Load cap. kg	Support cap. kg	Stackable
1200 / 1500 / 1200				
Internal dimensions w / d / h mm	65	600	1200	3 high
1065 / 1500 / 985				

Load surface height: 150 mm, underclearance: 100 mm. Robust steel tube, high-quality synthetic resin paint, galvanised steel base.
Colour: Light blue RAL 5012

Load example

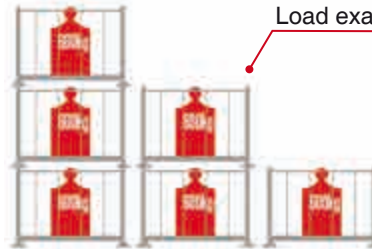

**CORDES stacking rack
with galvanised steel walls**



Article. No. **cs-120.507**

Dimensions W / D / H mm	Weight kg	Load cap. kg	Support cap. kg	Stackable
1200 / 1500 / 1200				
Internal dimensions w / d / h mm	83	600	1200	3 high
1065 / 1500 / 985				

Load surface height: 150 mm, underclearance: 100 mm. Robust steel tube, side walls lined with galvanised steel, high-quality synthetic resin paint, colour: Light blue RAL 5012

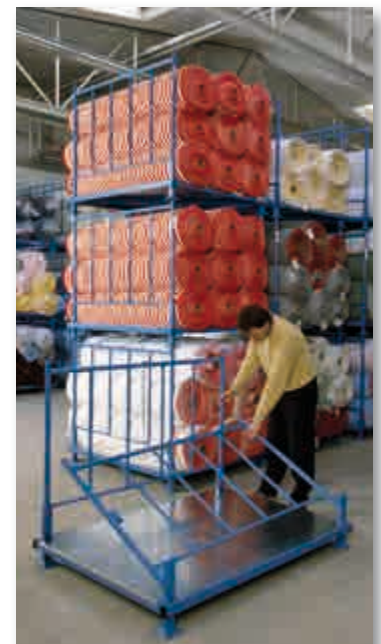

Vario stacking rack

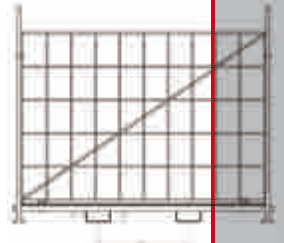

The mobile rack system with removable sides and rear walls. Can be dismantled and stacked to save space. High-quality synthetic resin paint.

Vario stacking rack

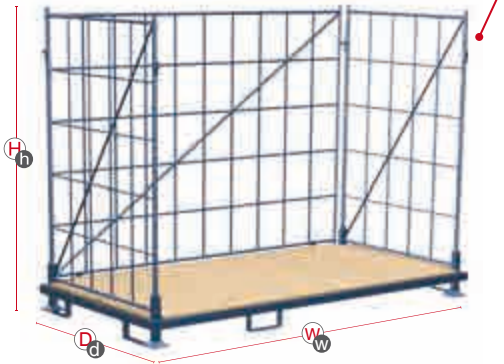

Article. No. **sl-240.102**

Dimensions W / D / H mm	Weight kg	Load cap. kg	Support cap. kg	Stackable
2400 / 1200 / 2000				
Internal dimensions w / d / h mm	114	500	2100	3 high
2260 / 1150 / 1800				

Load surface height: 165 mm, underclearance: 100 mm, colour: Light blue RAL 5012

Load example

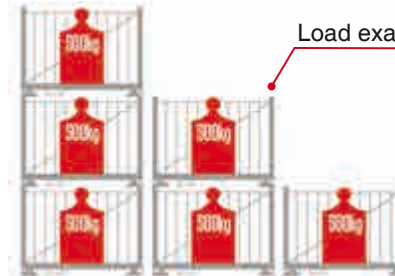

Vario stacking rack

nested model without base panel



When empty, Vario stacking racks can be dismantled and stacked to save space.



Available in all dimensions



Stackable



Low-rise stores



High-density stores



Expandable with accessories



closed by detachable side walls



Special design possible



individual adaptation



3 years warranty

Stack racks



Beer tent furniture rack

Bear tent furniture racks give your store more space thanks to 4-high stacking and greater flexibility thanks to fast, space-saving folding. The robust square-tube framework with foldable side elements ensures the necessary stability. Other advantages are reduced fire risk, permeability to fire-fighting water, great strength and low weight.



Available in all dimensions



Stackable



Low-rise stores



High-density stores



Expandable with accessories



closed by drop-down side walls



Special design possible



individual adaptation



3 years warranty

Beer tent furniture rack



Beer tent furniture rack nested



Article. No. **sl-235.501**

Dimensions	Weight	Load cap.	Support cap.	Stackable
W / D / H mm	kg	kg	kg	
2354 / 1120 / 1000				
Internal dimensions	122	400	1600	4 high
w / d / h mm				
2320 / 1095 / 780				

Sides can be flapped down in both directions, surface hot galvanised
Colour: hot galvanized



Load example

When empty, the heavy-duty stacking racks can be dismantled and stacked to save space.

For beer tent furniture sets of the following sizes

500 - 550 x 2200 mm (table)

250 - 255 x 2200 mm (bench)



Potato Box

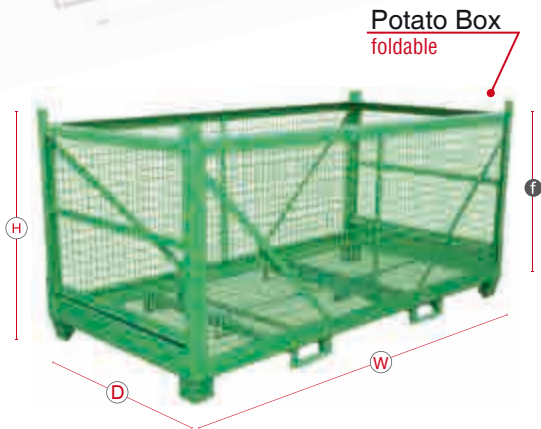

Removing the safety locks the box can be easily folded down in a few steps. This makes space saving storage on top of each other possible.

Art. No. **sg-224.000** mesh walls, foldable

Dimensions	Usable height	Weight	Load cap.	Support cap.	Stackable
B / T / H mm	f mm	kg	kg	kg	
2240 / 1120 / 1110	950	155	1500	6800	5-high

with mesh walls, sides: 25 x 50, bottom: 20 x 25 mm, 2 pcs. fork pockets, Colour: RAL 6018 yellow green, food grade

Potato Box rigid, with large front opening



small pouring spout









Info

further details on the following pages

Art. No. **sg-224.006** wood, rigid

Dimensions	Usable height	Weight	Load cap.	Support cap.	Stackable
B / T / H mm	f mm	kg	kg	kg	
2240 / 1120 / 1110	950	154	1500	6800	5-high

with wood, 2 pcs. fork pockets, Single wood parts replaceable, Colour: RAL 7032, food grade

-  Available in all dimensions
-  Stackable
-  Low-rise stores
-  High-density stores
-  Expandable with accessories
-  Special design possible
-  individual adaptation
-  3 years warranty



Potato Box



Available in all dimensions



Stackable



Low-rise stores



High-density stores



Expandable with accessories



Special design possible



individual adaptation



3 years warranty

Potato Box
foldable



Art. No. **sg-224.019** mesh walls with woodfloor, foldable

Dimensions B / T / H mm	Usable height f mm	Weight kg	Load cap. kg	Support cap. kg	Stackable
2240 / 1120 / 1100	950	156	1500	6800	5-high

with mesh walls, sides: 25 x 50, woodfloor, 2 pcs. fork pockets,
Colour: RAL 6018 yellow green, food grade

Potato Box
rigid



Art. No. **sg-224.001** mesh walls, rigid

Dimensions B / T / H mm	Usable height f mm	Weight kg	Load cap. kg	Support cap. kg	Stackable
2240 / 1120 / 1100	950	141	1500	6800	5-high

Floor and Sides with mesh walls, sides: 25 x 50 mm,
bottom : 25 x 25 mm, 2 pcs. fork pockets, Colour: RAL 7032, food grade



Potato Box

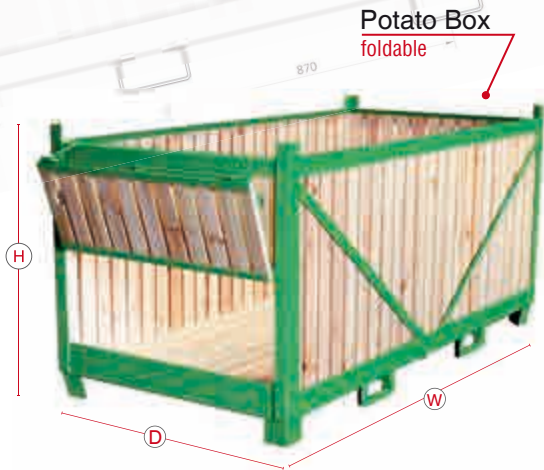

Art. No. **sg-224.018** wood, foldable

Dimensions	Usable height	Weight	Load cap.	Support cap.	Stackable
B / T / H mm	f mm	kg	kg	kg	
2240 / 1120 / 1110	950	154	1500	6800	5-high

with wood, 2 pcs. fork pockets,
Colour: RAL 6018 yellow green, food grade



Art. No. **sg-224.009** mesh walls with woodfloor, rigid

Dimensions	Usable height	Weight	Load cap.	Support cap.	Stackable
B / T / H mm	f mm	kg	kg	kg	
2240 / 1120 / 1110	950	150	1500	6800	5-high

with mesh walls, sides: 25 x 50, woodfloor, 2 pcs. fork pockets,
Colour: RAL 7032, food grade



Available in all dimensions



Stackable



Low-rise stores



High-density stores



Expandable with accessories



Special design possible



individual adaptation



3 years warranty

Stack racks



Potato Box



Available in all dimensions



Stackable



Low-rise stores



High-density stores



Expandable with accessories



Special design possible



individual adaptation



3 years warranty

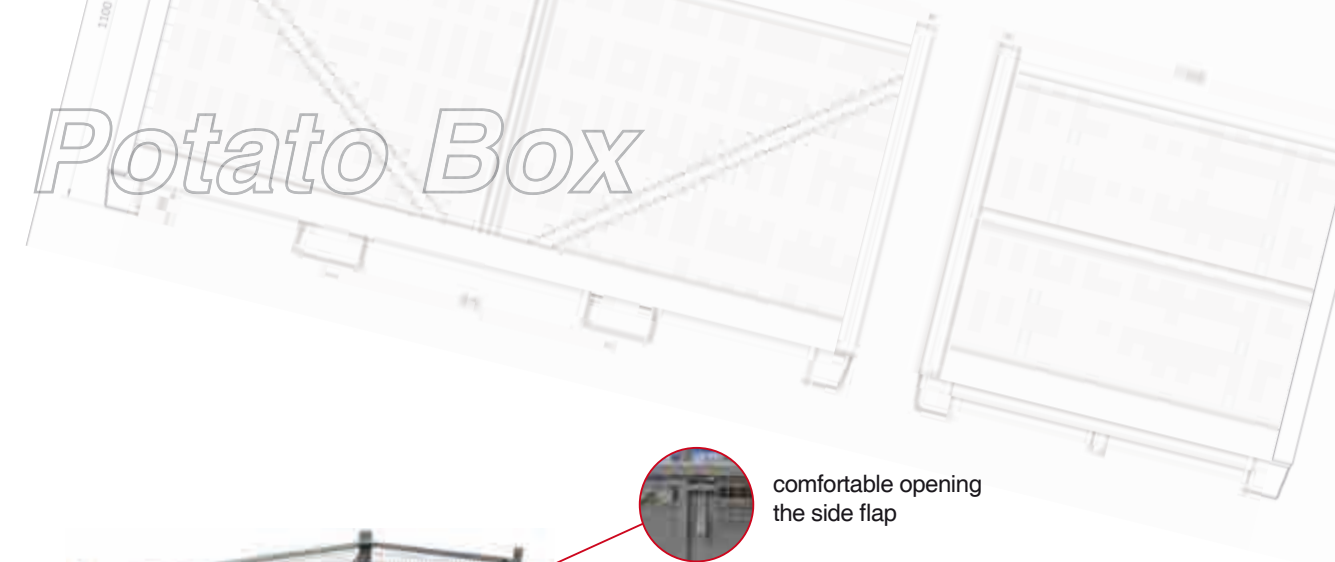

comfortable opening the side flap

Agricultural Box Variant for firewood

mesh walls, long side for folding

Technical details on request



Agricultural Box Variation for grain

Sides with sheet metal cladding, Nozzle sheet pan with outlet opening

Technical details on request



Nozzle plate floor



Automotive container

In the automobile industry, every new model requires a new load carrier. With a team of engineers and CAD draughtsmen, Cordes designs the right load carrier for the individual job. The components container is an example of such a solution used by an automobile components supplier.



Article No. **sg-150.001**

Dimensions W / D / H mm	Weight kg	Load cap. kg	Support cap. kg	Stackable
1200 / 1500 / 1435				
Internal dimensions w / d / h mm	168	150	2040	4 high
1100 / 1380 / 1245				

side walls with sheet steel inside, square-section tubes outside,
units stackable,
colour: Gentian Blue RAL 5010



- Available in all dimensions
- Stackable
- Low-rise stores
- Expandable with accessories
- Special design possible
- individual adaptation
- 3 years warranty

Stack racks



Automotiv-Container



Available in all dimensions



Stackable



Low-rise stores



Expandable with accessories



Verdichtung durch zusammenklappen



Special design possible



individual adaptation



3 years warranty



Automotiv-Container

Article. No. **sg-160.578**

Dimensions W/D/H mm	Weight kg	Load cap. kg	Support cap. kg	Stackable
1600 / 1200 / 760	102	300	2100	6 high
Internal dimensions w/d/h mm				
1520 / 1120 / 600				



Automotiv-Container
nested



Examples of use

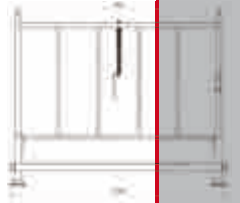

Stack racks

Examples of use

Stack racks



4 high stacking



Examples of use



Stack racks

Examples of use

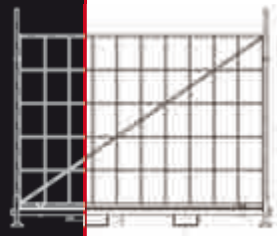

Pallet converter

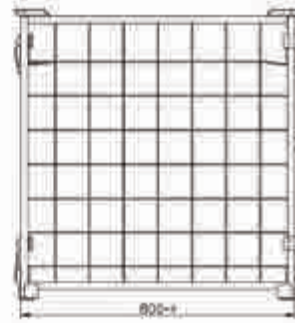
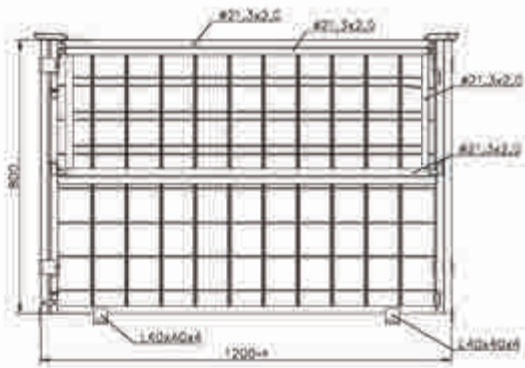
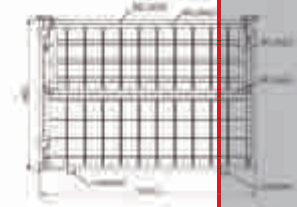

Pallet converter

Pallet converter



Pallet converter

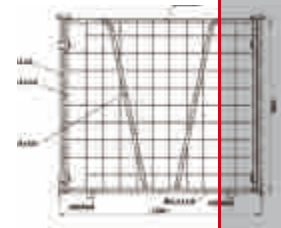

Robust tubular construction of welded steel – painted RAL 5012 light blue. Suitable for Euro and industry pallets. Can be collapsed or folded to save space when not in use. All pallet converters are available in various heights. Galvanised versions of all pallet converters are also available.

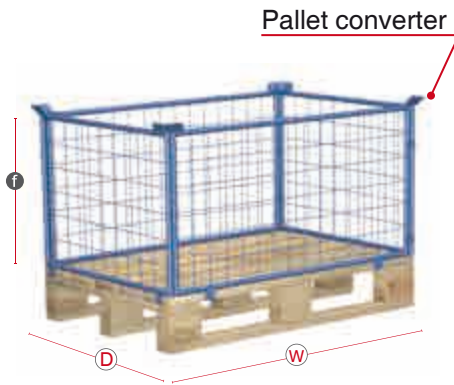

Pallet converter

Typ 62

Article. No.	Dimensions	Usable height	Weight	Support cap.	Stackable
	W / d mm	f mm			
pa-080.020	1200 / 800	400	13,5	1500	4 high
pa-080.021	1200 / 800	600	17,5	1500	4 high
pa-100.015	1200 / 1000	400	18,0	1500	4 high
pa-100.016	1200 / 1000	600	21,0	1500	4 high

All sides closed, wire mesh, mesh size 100 x 100 mm.

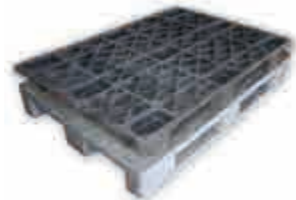

Plastic pallet

We can adapt a pallet converter for your plastic pallets too.



Pallet converter

Typ 63

Article. No.	Dimensions	Usable height	Weight	Support cap.	Stackable
	W / d mm	f mm			
pa-080.023	1200 / 800	800	19,0	1000	3 high
pa-080.024	1200 / 800	1000	22,0	1000	3 high
pa-080.025	1200 / 800	1200	24,0	750	3 high
pa-080.036	1200 / 800	1600	31,0	750	3 high
pa-100.018	1200 / 1000	800	24,0	1000	3 high
pa-100.019	1200 / 1000	1000	27,0	1000	3 high
pa-100.020	1200 / 1000	1200	29,0	750	3 high
pa-100.021	1200 / 1000	1600	32,5	750	3 high

All 4 sides closed with wire mesh, mesh size 100 x 100 mm, except for one 1200-mm side with V-cutout.



Available in all dimensions



Stackable



Low-rise stores



Expandable with accessories



Folds up to save space



Special design possible



individual adaptation



3 years warranty

Pallet converter



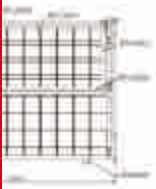

Pallet converter
with flap on one long side



Available in all dimensions



Stackable



Low-rise stores



Expandable with accessories



Folds up to save space



Special design possible



individual adaptation



3 years warranty



Pallet converter



Pallet converter separation grid

Article. No.	Dimensions mm		Weight kg
	B	f	
zpa-080.061	750	800 / 400	4,50
zpa-080.062	750	1000 / 500	5,20
zpa-080.063	750	1200 / 600	5,85
zpa-080.064	750	1600 / 800	7,70
zpa-100.010	950	800 / 400	5,50
zpa-100.011	950	1000 / 500	5,85
zpa-100.012	950	1200 / 600	6,60
zpa-100.013	950	1600 / 800	8,90

mesh size 100 x 100 mm only for Typ 62 and 64

Typ 64

Article. No.	Dimensions	Usable height	Weight	Support cap.	Stackable
	W / d mm	f mm	kg	kg	
pa-080.027	1200 / 800	800	21,0	1000	4 high
pa-080.028	1200 / 800	1000	22,5	1000	4 high
pa-080.029	1200 / 800	1200	26,5	750	4 high
pa-080.030	1200 / 800	1600	38,5	750	4 high
pa-100.022	1200 / 1000	800	21,5	1000	4 high
pa-100.023	1200 / 1000	1000	25,5	1000	4 high
pa-100.024	1200 / 1000	1200	31,5	750	4 high
pa-100.025	1200 / 1000	1600	39,0	750	4 high

All 4 sides closed with wire mesh, mesh size 100 x 100 mm, one long side with fold-down upper half (1200 mm)



folded

Typ 64

Article. No.	Dimensions	Usable height	Weight	Support cap.	Stackable
	B / T mm	f mm	kg	kg	
pa-080.567	1200 / 800	800	20,5	1000	4 high
pa-080.101	1200 / 800	600	20,5	1000	4 high

with folding lid

as pa-080.027, opening at one end.
Other sizes available on request.



Pallet converter separation grid

Article. No.	Dimensions mm		Weight kg
	B	f	
zpa-080.055	750	400	3,10
zpa-080.056	750	600	3,80
zpa-100.014	950	400	3,90
zpa-100.015	950	600	4,60
zpa-080.051	750	800	4,40
zpa-080.052	750	1000	5,10
zpa-080.053	750	1200	5,75
zpa-080.054	750	1600	7,60
zpa-100.022	950	800	5,40
zpa-100.023	950	1000	5,75
zpa-100.024	950	1200	6,50
zpa-100.025	950	1600	8,80

mesh size 100 x 100 mm only for Typ 62 and 64



Pallet converter

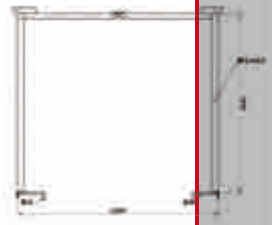

Robust tubular construction of welded steel – painted RAL 5012 light blue. Suitable for Euro and industry pallets. Can be collapsed or folded to save space when not in use. All pallet converters are available in various heights. Galvanised versions of all pallet converters are also available.

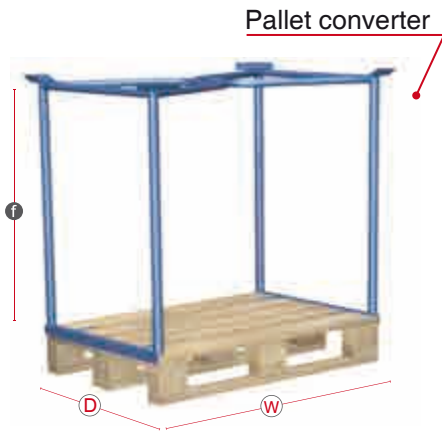

Pallet converter

Typ 65

Article. No.	Dimensions		Usable height f mm	Weight kg	Support cap. kg	Stackable
	W / d mm					
pa-080.005	1200 / 800		800	21,5	1500	3 high
pa-080.006	1200 / 800		1000	24,5	1500	3 high
pa-080.007	1200 / 800		1200	27,5	750	3 high
pa-080.008	1200 / 800		1600	30,5	750	3 high
pa-100.000	1200 / 1000		800	25,0	1500	3 high
pa-100.001	1200 / 1000		1000	27,0	1500	3 high
pa-100.002	1200 / 1000		1200	29,0	750	3 high
pa-100.003	1200 / 1000		1600	33,0	750	3 high

The pallet can be loaded from all sides



folded

For subsequent fitting to loaded Euro-pallet



Pallet converter

Typ 65K

Article. No.	Dimensions		Usable height f mm	Weight kg	Support cap. kg	Stackable
	W / d mm					
pa-080.300	1200 / 800		800	25,0	1500	3 high
pa-080.301	1200 / 800		1000	28,0	1500	3 high
pa-080.302	1200 / 800		1200	31,0	750	3 high
pa-080.303	1200 / 800		1600	34,0	750	3 high
pa-100.304	1200 / 1000		800	28,5	1500	3 high
pa-100.305	1200 / 1000		1000	30,5	1500	3 high
pa-100.306	1200 / 1000		1200	32,5	750	3 high
pa-100.307	1200 / 1000		1600	36,5	750	3 high

For subsequent fitting to loaded Euro-pallet. Frame secured by manual clamping function.

Do not move when stacked!



Pallet converter



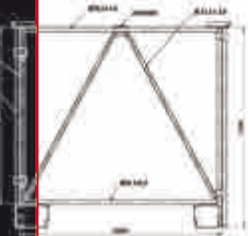

Pallet converter
with 3 shelves



Typ 65

Article. No.	Dimensions	Weight	Support cap.	Stackable
	W / d mm	kg	kg	
auf Anfrage	1200 / 800	20,5	1000	3 high

as pa-080.008, but with 3 shelves (4 load surfaces), the pallet can be loaded from all sides

stacked

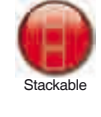

Pallet converter



Typ 66

Article. No.	Dimensions	Usable height	Weight	Support cap.	Stackable
	W / d mm	f mm	kg	kg	
pa-080.009	1200 / 800	800	28,0	500	4 high
pa-080.010	1200 / 800	1000	31,5	500	3 high
pa-080.011	1200 / 800	1200	33,0	300	3 high
pa-100.005	1200 / 1000	800	23,0	500	4 high
pa-100.006	1200 / 1000	1000	33,0	500	3 high
pa-100.007	1200 / 1000	1200	36,0	300	3 high

Both long sides (1200 mm) are completely open. The two ends (800 / 1000 mm) are fitted with vertical tubular bars, incl. connecting bar for stabilising the frame.

Pallet converter



Typ 68

Article. No.	Dimensions	Usable height	Weight	Support cap.	Stackable
	W / d mm	f mm	kg	kg	
pa-080.012	1200 / 800	800	33,0	2000	3 high
pa-080.013	1200 / 800	1000	36,5	2000	3 high
pa-080.014	1200 / 800	1200	43,5	2000	3 high
pa-080.015	1200 / 800	1600	45,5	2000	3 high
pa-100.007	1200 / 1000	800	34,5	2000	3 high
pa-100.008	1200 / 1000	1000	38,5	2000	3 high
pa-100.009	1200 / 1000	1200	44,0	2000	3 high
pa-100.010	1200 / 1000	1600	52,0	2000	3 high

All 4 sides with diagonal tubes running from bottom corners to meet at top centre. Fits Euro-pallet.



Pallet converter

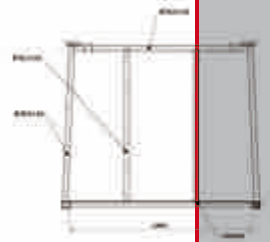

Robust tubular construction of welded steel – painted RAL 5012 light blue. Suitable for Euro and industry pallets. Can be collapsed or folded to save space when not in use. All pallet converters are available in various heights. Galvanised versions of all pallet converters are also available.

Pallet converter



Typ 75

Article. No.	Dimensions		Usable height f mm	Weight kg	Support cap. kg	Stackable
	W / d mm					
pa-080.016	1200 / 800		800	28,5	2000	4 high
pa-080.017	1200 / 800		1000	31,5	2000	4 high
pa-080.018	1200 / 800		1200	34,5	1000	3 high
pa-080.019	1200 / 800		1600	38,5	1000	3 high
pa-100.011	1200 / 1000		800	30,0	1000	4 high
pa-100.012	1200 / 1000		1000	33,0	1000	4 high
pa-100.013	1200 / 1000		1200	35,5	500	3 high
pa-100.014	1200 / 1000		1600	41,0	500	3 high

The short sides (ends) are completely open (800 mm)

folded



Pallet converter
3 sides open



Typ 75

Article. No.	Dimensions		Usable height f mm	Weight kg	Support cap. kg	Stackable
	W / d mm					
pa-080.112	1200 / 800		800	20,0	1500	4 high

as pa-080.016, but one long side and two ends open



Available in all dimensions



Stackable



Low-rise stores



Expandable with accessories



Folds up to save space



Special design possible



individual adaptation



3 years warranty

Pallet converter



Pallet converter galvanized

Robust tubular construction of welded steel. Fits Euro-pallets and industry pallets. Can be collapsed or folded to save space when not in use. All pallet converters are hot galvanized and available in various heights

-  Available in all dimensions
-  Stackable
-  Low-rise stores
-  Expandable with accessories
-  Weatherproof
-  Special design possible
-  Individual adaptation
-  3 years warranty

Pallet converter



Typ 75

Article. No.	Dimensions	Usable height	Weight	Support cap.	Stackable
	W / d mm	f mm	kg	kg	
vpa-080.016	1200 / 800	800	28,5	2000	4 high
vpa-080.017	1200 / 800	1000	31,5	2000	4 high
vpa-080.018	1200 / 800	1200	34,5	1000	3 high
vpa-080.019	1200 / 800	1600	38,5	1000	3 high
vpa-100.011	1200 / 1000	800	30,0	1000	4 high
vpa-100.012	1200 / 1000	1000	33,0	1000	4 high
vpa-100.013	1200 / 1000	1200	35,5	500	3 high
vpa-100.014	1200 / 1000	1600	41,0	500	3 high

The short sides (ends) are completely open (800 mm)

folded



Pallet converter
3 sides open



Typ 75

Article. No.	Dimensions	Usable height	Weight	Support cap.	Stackable
	W / d mm	f mm	kg	kg	
vpa-080.112	1200 / 800	800	20,0	1500	4 high

as pa-080.016, but one long side and two ends open



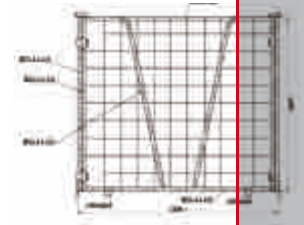

Pallet converter *galvanized*

Pallet converter

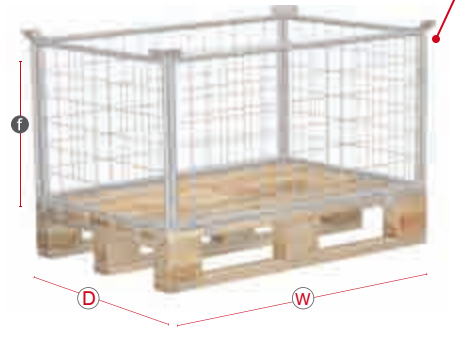

Typ 62

Article. No.	Dimensions W / d mm	Usable height f mm	Weight kg	Support cap. kg	Stackable
vpa-080.020	1200 / 800	400	13,5	1500	4 high
vpa-080.021	1200 / 800	600	17,5	1500	4 high
vpa-100.015	1200 / 1000	400	18,0	1500	4 high
vpa-100.016	1200 / 1000	600	21,0	1500	4 high

All sides closed, wire mesh, mesh size 100 x 100 mm.

Plastic pallet

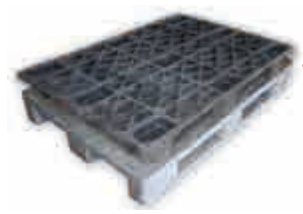

We can adapt a pallet converter for your plastic pallets too.

Pallet converter



Typ 63

Article. No.	Dimensions		Usable height f mm	Weight kg	Support cap. kg	Stackable
	W / d mm					
vpa-080.023	1200 / 800		800	19,0	1000	3 high
vpa-080.024	1200 / 800		1000	22,0	1000	3 high
vpa-080.025	1200 / 800		1200	24,0	750	3 high
vpa-080.036	1200 / 800		1600	31,0	750	3 high
vpa-100.018	1200 / 1000		800	24,0	1000	3 high
vpa-100.019	1200 / 1000		1000	27,0	1000	3 high
vpa-100.020	1200 / 1000		1200	29,0	750	3 high
vpa-100.021	1200 / 1000		1600	32,5	750	3 high

All 4 sides closed with wire mesh, mesh size 100 x 100 mm, except for one 1200-mm side with V-cutout.



Available in all dimensions



Stackable



Low-rise stores



Expandable with accessories



Weatherproof

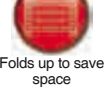

Folds up to save space



Special design possible

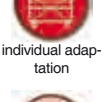

individual adaptation



3 years warranty

Pallet converter



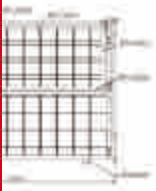

Pallet converter with flap on one long side



Available in all dimensions



Stackable



Low-rise stores



Expandable with accessories



Weatherproof



Folds up to save space



Special design possible



Individual adaptation



3 years warranty



Pallet converter



Pallet converter separation grid

Article. No.	Dimensions mm		Weight kg
	B	f	
zpa-080.161	750	800 / 400	4,50
zpa-080.162	750	1000 / 500	5,20
zpa-080.163	750	1200 / 600	5,85
zpa-080.164	750	1600 / 800	7,70
zpa-100.110	950	800 / 400	5,50
zpa-100.111	950	1000 / 500	5,85
zpa-100.112	950	1200 / 600	6,60
zpa-100.113	950	1600 / 800	8,90

mesh size 100 x 100 mm only for Typ 62 and 64

Typ 64

Article. No.	Dimensions	Usable height	Weight	Support cap.	Stackable
	W / d mm	f mm	kg	kg	
vpa-080.027	1200 / 800	800	21,0	1000	4 high
vpa-080.028	1200 / 800	1000	22,5	1000	4 high
vpa-080.029	1200 / 800	1200	26,5	750	4 high
vpa-080.030	1200 / 800	1600	38,5	750	4 high
vpa-100.022	1200 / 1000	800	21,5	1000	4 high
vpa-100.023	1200 / 1000	1000	25,5	1000	4 high
vpa-100.024	1200 / 1000	1200	31,5	750	4 high
vpa-100.025	1200 / 1000	1600	39,0	750	4 high

All 4 sides closed with wire mesh, mesh size 100 x 100 mm, one long side with fold-down upper half (1200 mm)

folded



Typ 64

Article. No.	Dimensions	Usable height	Weight	Support cap.	Stackable
	B / T mm	f mm	kg	kg	
on request	1200 / 800	800	20,5	1000	4 high

with folding lid

pa-080.101	1200 / 800	600	20,5	1000	4 high
------------	------------	-----	------	------	--------

as vpa-080.027, opening at one end.
Other sizes available on request.

Pallet converter separation grid

Article. No.	Dimensions mm		Weight kg
	B	f	
zpa-080.155	750	400	3,10
zpa-080.156	750	600	3,80
zpa-100.114	950	400	3,90
zpa-100.115	950	600	4,60
zpa-080.151	750	800	4,40
zpa-080.152	750	1000	5,10
zpa-080.153	750	1200	5,75
zpa-080.154	750	1600	7,60
zpa-100.122	950	800	5,40
zpa-100.123	950	1000	5,75
zpa-100.124	950	1200	6,50
zpa-100.125	950	1600	8,80

mesh size 100 x 100 mm only for Typ 62 and 64



Pallet converter

galvanized

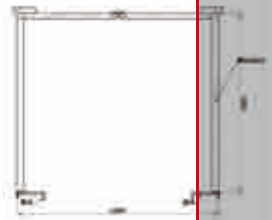

Robust tubular construction of welded steel. Fits Euro-pallets and industry pallets. Can be collapsed or folded to save space when not in use. All pallet converters are available in various heights.

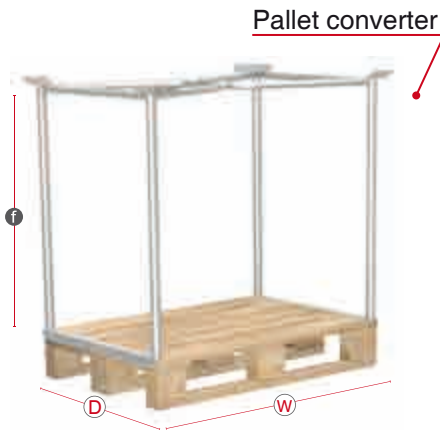

Pallet converter

Typ 65

Article. No.	Dimensions		Usable height f mm	Weight kg	Support cap. kg	Stackable
	W / d mm					
vpa-080.005	1200 / 800		800	21,5	1500	3 high
vpa-080.006	1200 / 800		1000	24,5	1500	3 high
vpa-080.007	1200 / 800		1200	27,5	750	3 high
vpa-080.008	1200 / 800		1600	30,5	750	3 high
vpa-100.000	1200 / 1000		800	25,0	1500	3 high
vpa-100.001	1200 / 1000		1000	27,0	1500	3 high
vpa-100.002	1200 / 1000		1200	29,0	750	3 high
vpa-100.003	1200 / 1000		1600	33,0	750	3 high

The pallet can be loaded from all sides



folded

For subsequent fitting to loaded Euro-pallet



Pallet converter

Typ 65K

Article. No.	Dimensions		Usable height f mm	Weight kg	Support cap. kg	Stackable
	W / d mm					
vpa-080.300	1200 / 800		800	25,0	1500	3 high
vpa-080.301	1200 / 800		1000	28,0	1500	3 high
vpa-080.302	1200 / 800		1200	31,0	750	3 high
vpa-080.303	1200 / 800		1600	34,0	750	3 high
vpa-100.304	1200 / 1000		800	28,5	1500	3 high
vpa-100.305	1200 / 1000		1000	30,5	1500	3 high
vpa-100.306	1200 / 1000		1200	32,5	750	3 high
vpa-100.307	1200 / 1000		1600	36,5	750	3 high

For subsequent fitting to loaded Euro-pallet.
Frame secured by manual clamping function.
Do not move when stacked!



Available in all dimensions



Stackable



Low-rise stores



Expandable with accessories



Weatherproof



Folds up to save space



Special design possible



individual adaptation



3 years warranty



Pallet converter

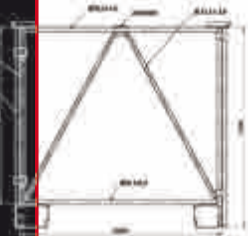

Pallet converter
with 3 shelves



Pallet converter



Pallet converter



Typ 65

Article. No.	Dimensions W / d mm	Weight kg	Support cap. kg	Stackable
auf Anfrage	1200 / 800	20,5,0	1000	4 high

as pa-080.008, but with 3 shelves (4 load surfaces), the pallet can be loaded from all sides

stacked



Typ 66

Article. No.	Dimensions W / d mm	Usable height f mm	Weight kg	Support cap. kg	Stackable
vpa-080.009	1200 / 800	800	28,0	500	4 high
vpa-080.010	1200 / 800	1000	31,5	500	3 high
vpa-080.011	1200 / 800	1200	33,0	300	3 high
vpa-100.005	1200 / 1000	800	23,0	500	4 high
vpa-100.006	1200 / 1000	1000	33,0	500	3 high
vpa-100.007	1200 / 1000	1200	36,0	300	3 high

Both long sides (1200 mm) are completely open. The two ends (800 / 1000 mm) are fitted with vertical tubular bars, incl. connecting bar for stabilising.

Typ 68

Article. No.	Dimensions W / d mm	Usable height f mm	Weight kg	Support cap. kg	Stackable
vpa-080.012	1200 / 800	800	33,0	2000	3 high
vpa-080.013	1200 / 800	1000	36,5	2000	3 high
vpa-080.014	1200 / 800	1200	43,5	2000	3 high
vpa-080.015	1200 / 800	1600	45,5	2000	3 high
vpa-100.007	1200 / 1000	800	34,5	2000	3 high
vpa-100.008	1200 / 1000	1000	38,5	2000	3 high
vpa-100.009	1200 / 1000	1200	44,0	2000	3 high
vpa-100.010	1200 / 1000	1600	52,0	2000	3 high

All 4 sides with diagonal tubes running from bottom corners to meet at top centre. Fits Euro-pallet.



Available in all dimensions



Stackable



Low-rise stores



Expandable with accessories



Weatherproof



Folds up to save space



Special design possible



individual adaptation



3 years warranty



Examples of use

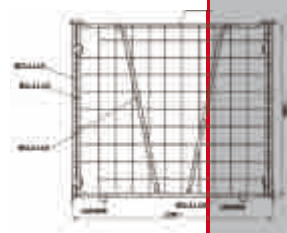

Pallet converter

Examples of use

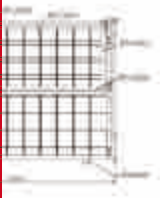

Individual solutions

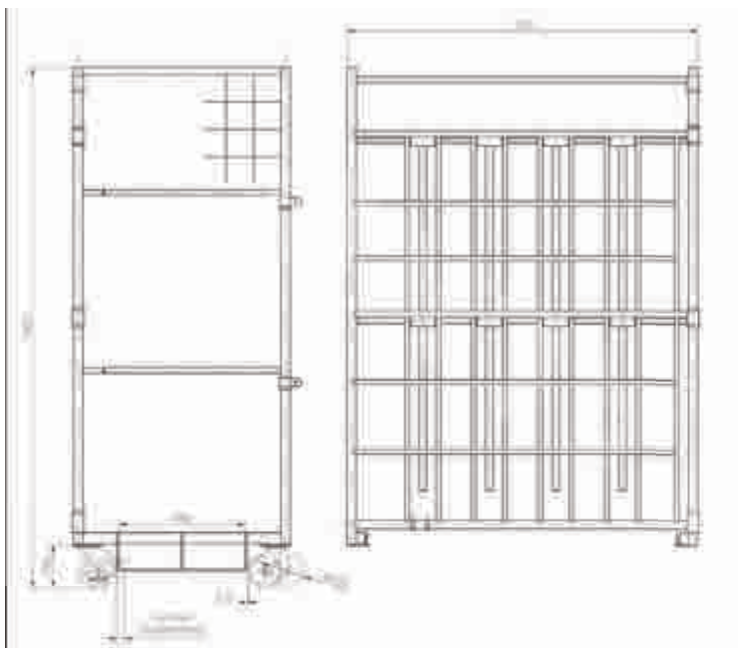
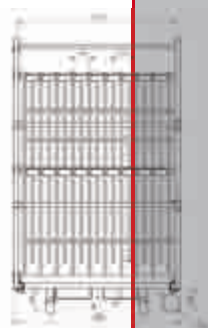

Individual solutions

Individual solutions

Individual solutions

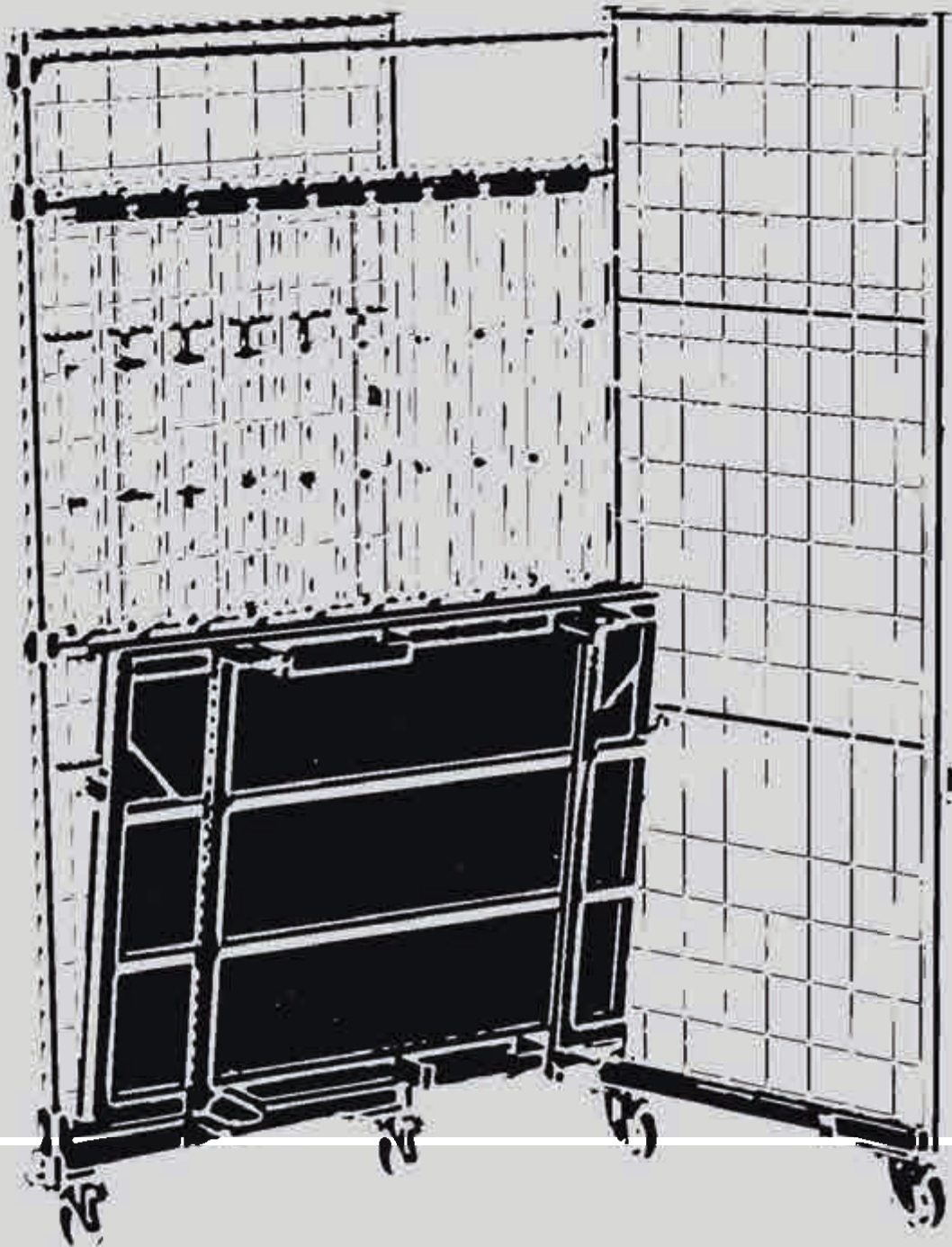

Textile container

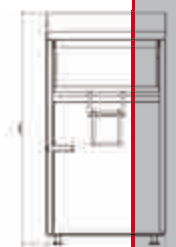

The garment container is designed specifically for collecting clothes in the public sector. Robust removal door with internal locking mechanism and integrated security lock. Theft-proof input opening. Simple operation.

Garment container



Article. No. **ac-115.001**

Dimensions W / D / H mm	Weight kg	Stackable
1150 / 1150 / 2200	215	-

ground clearance: 90 mm. Hot-dip galvanized steel plate. Free choice of colour



weatherproof



Available in all dimensions



Expandable with accessories



Special design possible



individual adaptation



3 years warranty

Textile container
incl. 4 inserts



Article. No. **sl-200.006**

Dimensions W / D / H mm	Weight kg	Load cap. kg	Support cap. kg	Stackable
2000 / 1500 / 1900	110	1000	2000	3 high
Internal dimensions w / d / h mm				
1920 / 1420 / 1700				

Underclearance: 95 mm, light blue RAL 5012

Reinforced edge protection for inserts above stacker tunnel

Colour: Light blue RAL 5012



Stackable



Low-rise stores



Individual solutions

Rolling garment rack

The rolling garment rack is made individually to meet the customer's requirements. Its Z-profile design permits nesting to save space. Large, small, long or narrow, the rolling garment stand can be supplied in any desired size. Chrome-plated oval tube. The rolling garment stand can also be supplied as a galvanised version on request.



Available in all dimensions



Expandable with accessories



Special design possible



individual adaptation



3 years warranty

Rolling garment rack



Article. No. **sg-156.500**

Dimensions	Weight	Load cap.	Wheel diam.
W / D / H mm	kg	kg	mm
1560 / 590 / 1800	21	150	100

Robust tubular steel frame 1 inch = 34 mm thick, oval tube 38 x 20, chrome-plated. Colour: Light blue RAL 5012

Wheels: 4 x 100 mm solid rubber swivel castors

Also available as double rolling garment stand

Article. No. **sg-180.002**

Dimensions	Weight	Load cap.	Wheel diam.
W / D / H mm	kg	kg	mm
1800 / 700 / 1800	23	150	100

Robust tubular steel frame 1 inch = 34 mm thick, oval tube 38 x 20, chrome-plated. Colour: Light blue RAL 5012

Wheels: 4 x 100 mm rubber swivel castors

Leather transport trolley



Article. No. **sp-250.012**

Dimensions	Weight	Load cap.	Wheel diam.
W / D / H mm	kg	kg	mm
2750 / 750 / 1530	137	800	150

Colour: White aluminium RAL 9006

Wheels: 4 x 150 mm polyurethane swivel castors (96° Shore)



Silencer box

An individual special model for easy, sorted transport of exhaust pipes with silencers. Open side with flat-steel edge to prevent load sliding out. Base of 16-mm chipboard. 2 levels with guide bars, creating 10 compartments. With stacker pockets and foldable rack runners. High-quality synthetic resin paint finish

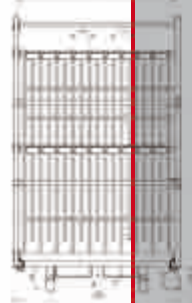

Silencer box

Article. No. **sg-120.521**

Dimensions	Weight	Load cap.	Support cap.	Stackable	Wheel diam.
W / D / H mm	kg	kg	kg		mm
1200 / 800 / 2000					
Internal dimensions	102	500	-	-	125
w / d / h mm					
1110 / 750 / 1770					

Underclearance: 165 mm. Mesh size at sides: 100 x 100 mm, back with flat steel grating.
Colour: Orange RAL 2004
Wheels: 4 x 125 mm polyurethane swivel castors (96° Shore)



Silencer box
nested

To make optimum use of space the silencer box was developed with a folding mechanism. Nesting can save up to 65% space. Suitable for racks, thanks to foldable rack runners.



Available in all dimensions



Stackable



Low-rise stores



Expandable with accessories



nested



Special design possible



individual adaptation



3 years warranty

Individual solutions



Rolling Cortainer

Rolling Cortainer, a robust but manoeuvrable load carrier for distribution logistics. Can be quickly folded up and nested when not in use. Optionally with lid and front doors for theft-proof materials handling.



Available in all dimensions



Expandable with accessories



Special design possible



individual adaptation



3 years warranty

Rolling Cortainer



Article. No. **sg-102.001**

Dimensions	Weight	Load cap.	Support cap.	Stackable	Wheel diam.
W / D / H mm	kg	kg	kg		mm
1090 / 750 / 1700					
Internal dimensions	77	500	-	-	125
w / d / h mm					
990 / 630 / 1420					

Mesh size: 50 x 100 mm,

Colour: galvanized

Wheels: 4 x 125 mm plastic swivel castors, incl. 2 with wheel direction lock

Laundry trolley



Article. No. **sg-120.530**

Dimensions	Weight	Load cap.	Support cap.	Stackable	Wheel diam.
W / D / H mm	kg	kg	kg		mm
1200 / 560 / 1810					
Internal dimensions	52	500	-	-	100
w / d / h mm					
1145 / 515 / 1645					

Underclearance: 130 mm,

Mesh size: 50 x 50 mm,

Colour: galvanized

Wheels: 4 x 100 mm plastic swivel castors

The laundry trolley was developed for delivering and collecting laundry. The two upper wire-mesh levels can be inserted downwards into the slots provided to create an enclosed mesh box.



Rolling container

Robust tubular steel frame with wire shelf body, electro-galvanised. The rolling container is supplied with 2 securing straps. Optionally with intermediate shelves and front and rear wall. 



Article No. **sg-714.005**

Dimensions	Weight	Load cap.	Support cap.	Stackable	Wheel diam.
W / D / H mm	kg	kg	kg		mm
710 / 793 / 1908					
Internal dimensions	35	500	-	-	100
657 / 793 / 1702					

Underclearance: 130 mm
 Colour: electro-galvanised
 Wheels: 2 x 100 mm plastic swivel castors, 2 x 100 mm plastic fixed castors

Intermediate shelves

Accessories



Article No. **zsg-714.005** Intermediate shelves

Dimensions	Weight	Load cap.
W / D mm	kg	kg
657 / 793	6	60

Wire mesh size 50 x 50 mm
 Surface: electro-galvanised

Front/ rear wall

Accessories



Article No. **zsg-714.003** Front/ rear wall

Dimensions	Weight	Load cap.
W / H mm	kg	kg
714 / 1871	8	-

Wire mesh size 50 x 50 mm
 Surface: electro-galvanised



Available in all dimensions



Stackable



Low-rise stores



Expandable with accessories



Verdichtung durch zusammenklappen



Special design possible



individual adaptation



3 years warranty

Individual solutions



Cordes and logistics service providers

A distribution logistics project

Companies are handling less and less of their logistics themselves, but are increasingly outsourcing to logistics service providers. Producers are concentrating on their core competencies and leaving logistics to the specialists. In the context of such outsourcing projects, it is necessary to design more and more rolling containers and materials handling concepts. The following example describes how Cordes developed and produced three different load carriers for children's shoes in cooperation with a logistics service provider.

When the shoe boxes are delivered, they are sorted on a conveyor path and loaded into the order picker. Large batches are stored in a rack, if necessary using pallet converters.

Our Corlettes make it possible to transport an entire order without having to handle every single shoe box.

An automatic chain conveyor in combination with an elevator makes it possible to use the Corlettes and order-pickers at the second level.

After sorting in the order picker, all shoe boxes pass through a scanner curtain and are thus captured in a single operation, before being placed ready for shipment.

Individual solutions

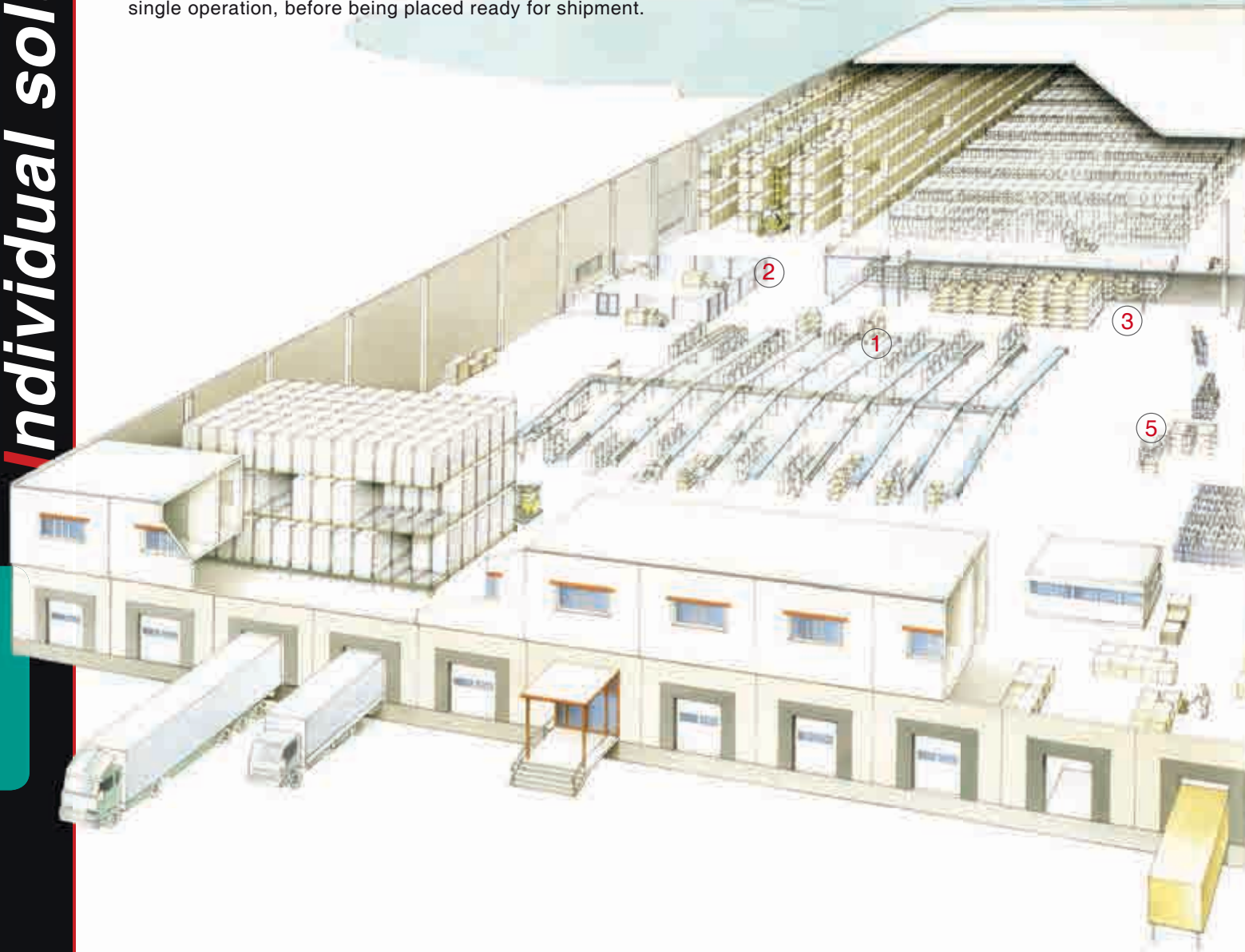



1

When the shoe boxes are delivered, they are sorted on a conveyor path and loaded into the order picker.

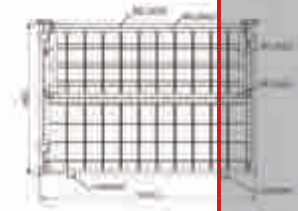

2

Large batches are stored in a rack, if necessary using pallet converters.



3

Our Corlettes make it possible to transport an entire order without having to handle every single shoe box.



4

An automatic chain conveyor in combination with an elevator makes it possible to use the Corlettes and order-pickers at the second level.



5

After sorting in the order picker, all shoe boxes pass through a scanner curtain and thus captured in a single operation, before being placed ready for shipment.

Order-picking trolley

The order-picking trolley was developed and produced jointly by Cordes and a logistics service provider as a load carrier for children's shoes, see Chapter F 1.31.



Available in all dimensions



Expandable with accessories



Special design possible



individual adaptation



3 years warranty

Order-picking trolley



Article. No. **sg-180.500**

Dimensions	Weight	Load cap.	Support cap.	Stackable	Wheel diam.
W / D / H mm	kg	kg	kg		mm
1800 / 700 / 1860					
Internal dimensions	106	500	-	-	160
w / d / h mm					
800 / 340 / 750					

Underclearance: 240 mm,

Mesh size: 50 x 50 mm,

Colour: Gentian blue RAL 5010

Wheels: 4 x 160 mm rubber castors: 2 swivel castors with central foot brake and 2 fixed castors

Magazine trolley



Article. No. **zw-991.500**

Dimensions	Weight	Load cap.	Support cap.	Stackable	Wheel diam.
W / D / H mm	kg	kg	kg		mm
1370 / 2x400 / 1620					
Internal dimensions	71	1000	-	-	200
w / d / h mm					
1185 / 2x400 / 1320					

Load surface height: 365 mm

Colour: Light blue RAL 5012

Wheels: 2 x 200 mm plastic swivel castors, 2 x 200 mm plastic fixed castors



nested

In the wholesale press and publishing world, weights quickly reach very high levels. Order-picking of magazines or newspapers requires a load carrier that ensures easy handling and safe distribution of the products. Since the base has a slight inward tilt, the magazines cannot fall out. The shelves can be flapped up against the central wall. This permits nesting of the trolleys to save space.



Order-picking trolley

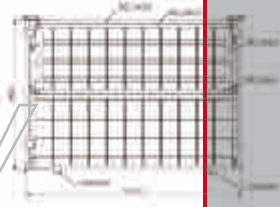

Order-picking trolley



Art. No. **sg-130.107**

Dimensions	Weight	Load cap.	Support cap.	Stackable	Wheel diam.
B / T / H mm	kg	kg	kg		mm
1300 / 625 / 1800					
Internal dimensions	84	400	-	-	125
850 / 500					

Side and back wall with wire mesh 50 x 50 mm
 2 compartments with each 3 two-times foldable shelves with mesh 600 x 600 mm,
 base construction for pick up with forklifter and conveyor technology
 4 x 125 mm thermoplastic rubber swivel wheels on plastic rim
 and 1 fixed mid wheel

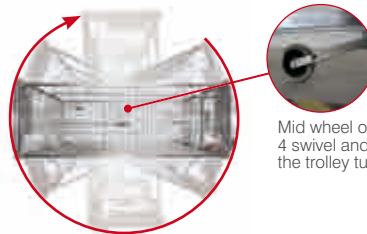

Mid wheel on option:
 4 swivel and 1 mid wheel let
 the trolley turn on spot

Order-picking trolley



Art. No. **sg-130.102**

Dimensions	Weight	Load cap.	Support cap.	Stackable	Wheel diam.
B / T / H mm	kg	kg	kg		mm
1435 / 490 / 1835					
Internal dimensions	70	300	-	-	125
1248 / 457 / 1534					

Side and back wall with wire mesh 50 x 50 mm
 2 pieces vertical push bars painted RAL 2008 ladder with
 3 steps foldable made of laminated plywood,
 surface screen print bottle holder, document pocket A4,
 4 x 125 mm thermoplastic rubber swivel wheels on plastic rim and a 5th wheel electrically
 conductive under the trolley

-  Available in all dimensions
-  Available in all dimensions
-  Expandable with accessories
-  Special design possible
-  individual adaptation
-  3 years warranty

Individual solutions



Order-picking trolley



Available in all dimensions



Available in all dimensions



Expandable with accessories



Special design possible



individual adaptation



3 years warranty



Parcel trolley



Art. No. **sg-120.100**

Dimensions B / T / H mm	Weight kg	Load cap. kg	Support cap. kg	Stackable	Wheel diam. mm
1200 / 800 / 1900					
Internal dimensions b / t / h mm	80	500	-	-	160
1108 / 750 / 1655					

Side and back wall with mesh: 100 x 50 mm, automatic bottom lock, shaft with support and coupling. 160 mm thermoplastic wheels, 2 swivel ones with central direction lock and 2 central brake wheels

Order-picking trolley



Art. No. **sg-150.015**

Dimensions B / T / H mm	Weight kg	Load cap. kg	Support cap. kg	Stackable	Wheel diam. mm
1500 / 620 / 1900					
Internal dimensions b / t / h mm	67	300	-	-	125
1248 / 590 / 600					

Side and back wall with wire mesh: 40 x 40 mm incl. 5 shelves, variable insertion at 40 mm intervals for shelf divider, incl. 20 shelf divider for shelf with wire mesh, 4 x 125 mm thermoplastic swivel wheels on plastic rim with precision ball bearing and a 5th wheel under the trolley with central brae EasySTOP, handable from 2 sides brake all wheels



Mid wheel on option:
4 swivel and 1 mid wheel
let the trolley turn on spot



Distributors

International



Belgien

DE RONDE & DRUBBEL N.V.
Ijzerlaan 7
B-2060 Antwerpen
Tel.: +32 3 225 00 16
Fax: +32 3 232 18 03
www.de-ronde.com
i.folders@de-ronde.com



Irland

Liftrite LTD
Unit F1 Business Campus
Maynooth
IRL-Co Kildare
Tel.: +35 3 160 161 06
Fax: +35 3 160 161 09
www.liftrite.ie
info@liftrite.ie



Polen

CORDES Polen Sp. z.o.o.
ul. Przemysłowa 6
PL-88 300 Mogilno
Tel.: +48 52 3159 441/442
Fax: +48 52 3159 440
www.cordes.com.pl
info@cordes.com.pl



Dänemark

DANSK NIELS BO
Vognmagervej 10, Snoghøj
DK-7000 Fredericia
Tel.: +45 75 945 800
Fax: +45 75 945 888
www.nielsbo.dk
nb@nielsbo.dk



Italien

Italiana Contenitori S.r.L.
Via Grangia Marin 80
I-10094 Giaveno 9 (To)
Tel.: +39 011 937 57 65
Fax: +39 011 937 79 53
www.italianacontenitori.com
info@italianacontenitori.com



Schweden

Micrologistic AB
Tilverkarvägen 8
SE-187 66 Täby
Tel.: +46 8 544 401 50
Fax: +46 8 732 38 70
www.micrologistic.com
bjorn.carlsson@micrologistic.com



Finnland

Effekta Oy
Hyljeveneentie 1 D 8
FI-02260 Espo
Tel.: +358 988 162 340
www.effekta.fi
effektaoy@gmail.com



Niederlande

AARNOUDSE B.V.
Boerhaavelaan 21
NL-2992 KB Barendrecht
Tel.: +31 180 616 000
Fax: +31 180 617 987
www.aarnoudse.nl
info@aarnoudse.nl



Schweiz

CORDES Schweiz GmbH
Ettiswilerstrasse 24
CH-6130 Willisau
Tel.: +41 41 970 12 13
Fax: +41 62 756 21 74
www.cordes-schweiz.ch
monsich@cordes-schweiz.ch



Frankreich

Cordes France
85, rue de la Victoire
F-75009 Paris
Tel.: +48 52 315 9422
Fax: +48 52 315 9440
Tel.: +33 14 281 4499
ania@cordes.com.pl
www.cordes.eu



Norwegen

TRALLEFABRIKKEN AS
Nils Hansens vei 7
N-0667 OSLO
Tel.: +47 23 379 760
Fax: +47 23 379 767
www.trallefabrikken.no
firmapost@trallefabrikken.no



Spanien

Cordes Canarias, S.L.
Zona P3 Norte
Calle del Herraaje, Nave 27
Polígono Ind. de Arinaga
ES-35119 Agüimes, Gran Canaria
Tel.: +34 660 467 511
Fax: +34 928 180 676
www.cordescanarias.com
cordescanarias@cordescanarias.com



Großbritannien

Lift Safe LTD
Unit 9, Westwood Business Centre
Featherstall Road South
GB-OL9 6HN Oldham
Tel.: +44 161 626 96 28
Fax: +44 161 626 97 28
www.liftsafe.net
info@liftsafe.net



Norwegen

BBI BAVARIA IMPORT A/S
Postboks 38
N-1556 Son
Tel.: +47 649 586 35
Fax: +47 649 585 15
www.bbi-bavariaimport.no
info@bbi-bavariaimport.no



Südafrika

One Touch Retail Solutions
Po Box 612
Seapoint
RSA-8060 South Africa
Tel.: +27 84 60 06 999
Fax: +27 21 42 12 446
www.onetouchsolutions.co.za
sales@onetouchsolutions.co.za



Israel

5tools logistics technology
Koren Industrial Park
PO Box 9042
IL-21090 Maalot
Tel.: +972 4 999 75 75
Fax.: +972 4 999 70 75
www.comold.co.il
ron@5tools.co.il



Österreich

Gesa Transporttechnik Ing.
Gerhard Sandhofer GmbH
Hirschstraße 35
A-9020 Klagenfurt
Tel.: +43 463 341 140
Fax: +43 463 342 54
www.gesa.at
office@gesa.at



Frankreich

MANUEST CONCEPT S.A.
11 rue Ampère
F-67129 DUTTLENHEIM
Tél.: +33 3 884 978 78
Fax: +33 3 884 978 79
www.manuest.com
contact@manuest.com

Info 1.30

CORDES Worldwide



CORDES GmbH & Co.KG
Weißfelder Straße 1
D-21698 Harsefeld

Tel.: +49 (0) 4164 816-0
Fax: +49 (0) 4164 5427

email: info@cordes.eu
www.cordes.eu

CORDES  GOODS in motion